

Collection 2020

**master**light

# MASTERLIGHT

## COLLECTION

INDUSTRIA | CONCEPTO | HOME | PROJECTS



Since the foundation of the company in 1987, Masterlight has been a brand that reflects high quality and characteristic designs which originate from the creative skills of experienced designers.

By using only the best European materials and components for the production of our lighting fixtures as well as our professional knowledge of lighting in general, Masterlight continues to challenge the boundaries of artisanship.

In order to transform interiors and public spaces around the world.



**masterlight**

# INDEX

INDUSTRIA  
008/077

---

CONCEPTO  
078/187

---

HOME  
188/371

---

ADDITIONS  
372/385

---

PROJECTS  
386/413

---

GENERAL INFORMATION  
CONTACT  
414/421

---



## INDUSTRIA

## CONCEPTO

M. 2002	012/015	Arch	080/083
M. 2006	016/017	Aton	084/087
M. 2007	018/025	Boris	088/089
M. 2010	026/027	Boris XXL	090/091
M. 2011	028/031	Cage	092/095
M. 2012	032/033	Camillo	096/097
M. 2013	034/035	Casco	098/101
Air	036/037	Cesto	102/105
Di Panna	038/041	Cross	106/109
Di Panna 'Plumming'	042/043	Cup	110/113
Grid	044/049	Eifel	114/117
Larino	050/065	Esmee	118/123
Petrol	066/069	Globo	124/127
Prato	070/073	Lett	128/139
Prato 'Plumming'	074/075	Octo	140/143
Prato XL+XXL	076/077	Ogiva	144/145
		Pineapple	146/149
		Quinto	150/159
		Run	160/163
		Tessi	164/169
		Trip	170/177
		Tube	178/181
		Venus	182/183
		Zyan	184/187

## HOME

Al Tonno	192/193	Milan	298/303
Baldi	194/197	Modern Crown	304/305
Baloton	198/205	Molto II	306/309
Big 'Denia'	206/207	Molto III	310/315
Bocca	208/211	Moskow	316/319
Bolzano	212/215	O.A.K. 'Real Wood'	320/323
Bones	216/217	Oblica	324/325
Bounce	218/221	Ovum 'Vigo II'	326/327
Bubble	222/225	Plafonniere	328/333
Calabro	226/229	Real II 'Down'	334/337
Catarina	230/235	Real III 'Up+Down'	338/341
Cilindra	236/239	Roma	342/345
Corona	240/241	Solta	346/349
Curlie	242/243	Terra	350/351
Dante	244/247	Tondo	352/353
Denia I 'Square'	248/253	Torcello	354/357
Denia II 'Round'	254/257	Verona	358/361
Di Moda	258/261	Vesto	362/365
Donna	262/263	Vigo	366/371
Dopler 'Bronze/Silver'	264/271		
Flute	272/277		
Gio	278/281		
Iota	282/283		
Melani	284/289		
Metallico	290/295		
Mika	296/297		



# SYMBOLS

## MEASUREMENTS

L	Max - Length pendant (Excluded the shade height)
W	Max - Width
D	Depth
BH	Body Height
TH	Total Height
HS	Hole Size (Recessed in ceiling)
∅	Diameter Shade
SH	Shade Height

## LIGHTSOURCE

MW	Max Watt - LED
LS	E27/E14/GU10/G9 Lamp Socket
	All lighting fixtures are excluding light bulbs.
DIM	Dimmable
	● Yes on fixture
	○ Yes External (With a dimmable light source)
	⊗ Not Dimmable but contains On/Off switch
LW	LED Watt - Built-in
LM	Lumen
K	Kelvin
	Dim to Warm LED

**master**light



# INDUSTRIA

COLLECTION

**master**light

# INDEX



M. 2002  
012/015

---



M. 2006  
016/017

---



M. 2007  
018/025

---



M. 2010  
026/027

---



M. 2011  
028/031

---



M. 2012  
032/033

---



M. 2013  
034/035

---



Air  
036/037

---



Di Panna  
038/041

---



Di Panna 'Plumming'  
042/043

---



Grid  
044/049

---



Larino  
050/065

---



Petrol  
066/069

---



Prato  
070/073

---



Prato 'Plumming'  
074/075

---



Prato XL+XXL  
076/077

---

# PENDANT OPTIONS

| INDUSTRIA |



## Available pendant options

| Pleas consult available pendant options in the detailed series section |



-S

Cable



-EH-K

Block + cable



-K

Chain+cable



-EV-K

Chain+bow+block+cable



-ST

Steel wire+cable



-R-K

Chain+rings 'cooling ribs'+cable



-K-3ST

Chain+ 3x steel wire+cable



-3ST

Chain+ 3x steel wire+cable



-B

Chain+bow+cable



-CU-S

Cup+cable



-C

Cage 'steel wire'



-CU-K

Chain+cup+cable

# M.2002

SY0029003 | RECOMMENDED LED LIGHT BULB



05

Fixture/Frame Color

- Color options available for this collection -

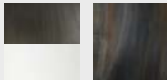

30-06 66-66

Shade Color





2002-66-66-BL



2002-30-06-BL

PRODUCT NUMBER	L	W	D	∅	SH	BH	TH	MW	LS	DIM
2002-....-....-BL	90cm			77,5cm	60cm	80cm		18w	E27	○







# M.2006

SY0028009 | RECOMMENDED LED LIGHT BULB



SY0026683

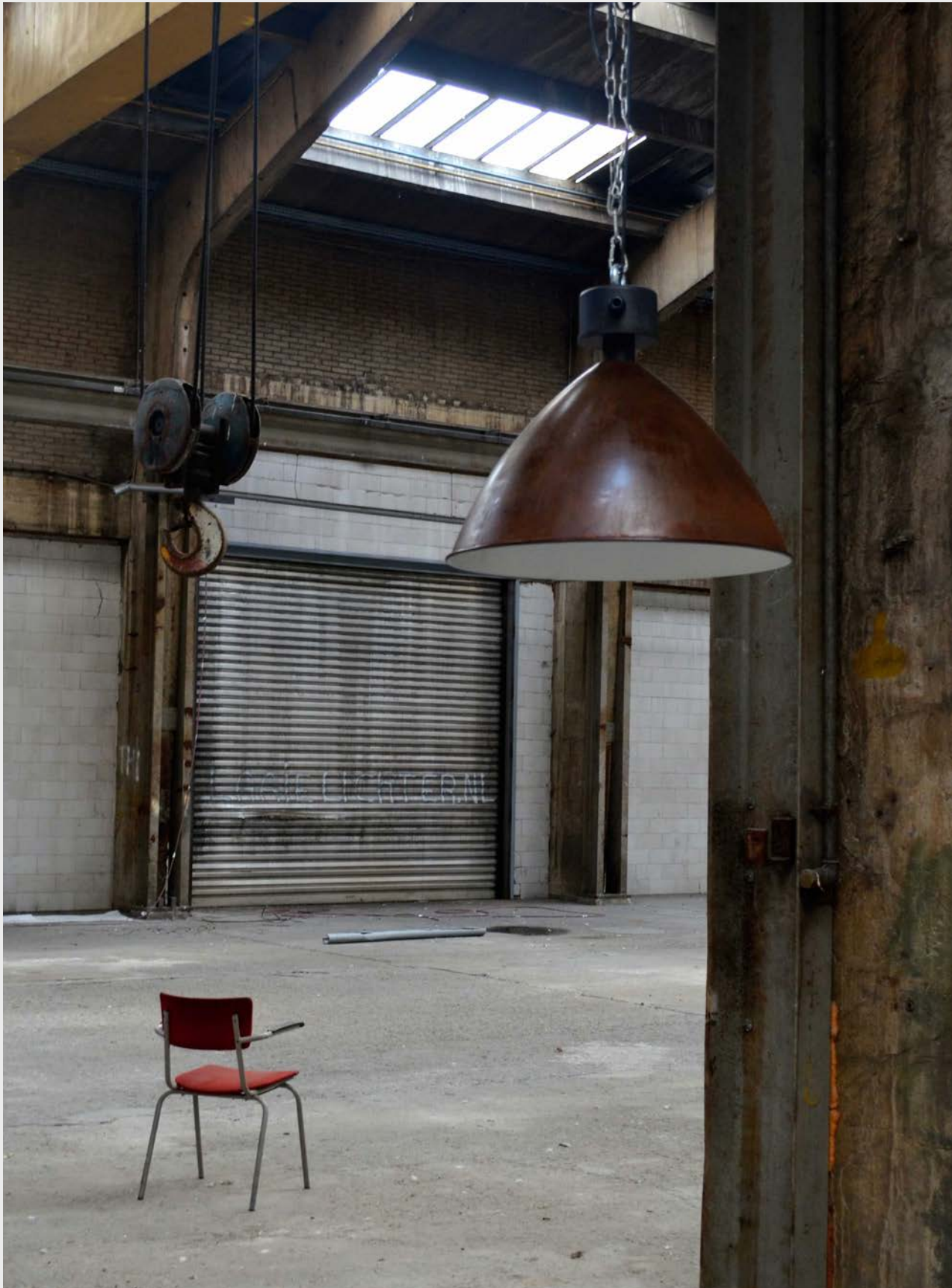

05

Fixture/Frame Color



00-00



05-05



06-06



10-10



25-06



30-06



55-55



66-66



75-75

- Color options available for this collection -

Shade Color



2006-....-....-K-130-2



2006-....-....-R-K



2006-....-....-EH-K



2006-....-....-K

PRODUCT NUMBER	L	W	D	∅	SH	BH	TH	MW	LS	DIM
2006-....-....-K	90cm			52,5cm	30cm	30cm		18w	E27	○
2006-....-....-R-K	90cm			52,5cm	30cm	50cm		18w	E27	○
2006-....-....-EH-K	90cm			52,5cm	30cm	42cm		18w	E27	○
2006-....-....-K-130-2	90cm	162cm		52,5cm	30cm	42cm		2x18w	E27	○

# M.2007

M.2007 | M.3005 / M.3006 | M.3008 / M.5008

SY0028006 | RECOMMENDED LED LIGHT BULB



SY0026683



05

Fixture/Frame Color



00-00



05-05



06-06



10-10



25-06



30-06



55-55



66-66



75-75

- Color options available for this collection -

Shade Color





2007-....-....-K



2007-....-....-B-K



2007-....-....-EH-K



3008-05-....-....

PRODUCT NUMBER	L	W	D	∅	SH	BH	TH	MW	LS	DIM
2007-....-....-K	90 cm			28 cm	32 cm	38 cm		18 w	E27	○
2007-....-....-B-K	90 cm			28 cm	32 cm	46 cm		18 w	E27	○
2007-....-....-EH-K	90 cm			28 cm	32 cm	47 cm		18 w	E27	○
3008-05-....-....				28 cm	32 cm		47 cm	18 w	E27	○



2007-.....-K-70-2



3008-05-.....



3006-05-.....

PRODUCT NUMBER	L	W	D	∅	SH	BH	TH	MW	LS	DIM
3006-05-.....			66,5cm	28cm	32cm		49cm	18w	E27	○
2007-.....-H-70-2	90cm	81cm		28cm	32cm	38cm		2x18w	E27	○
3008-05-.....				28cm	32cm		47cm	18w	E27	○



2007-.....-EH-K-130-3



3005-05-.....

PRODUCT NUMBER	L	W	D	∅	SH	BH	TH	MW	LS	DIM
2007-.....-130-3	90cm	137cm		28cm	32cm			3x18w	E27	○
3005-05-.....			34cm	28cm	32cm		44cm	18w	E27	○

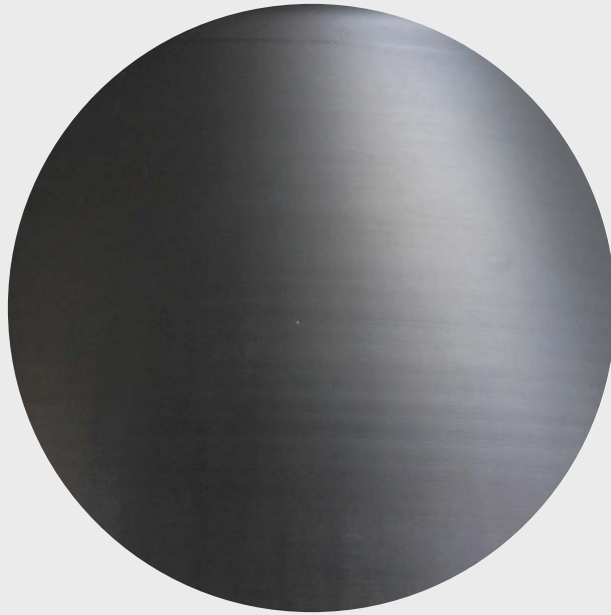



# M.2007 FLOOR LAMPS

SY0028006 | RECOMMENDED LED LIGHT BULB



SY0026683 |



05

Fixture/Frame Color



00-00



05-05



06-06



10-10



25-06



30-06



55-55



66-66



75-75

- Color options available for this collection -

Shade Color





1007-05-....-....

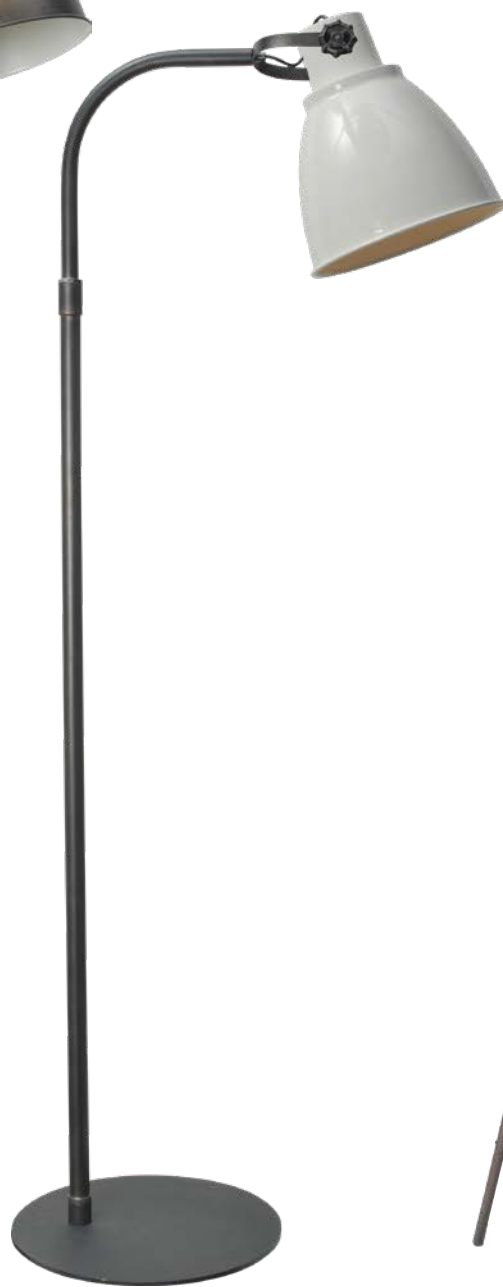

1008-05-....-....



1017-05-....-....

PRODUCT NUMBER	L	W	D	∅	SH	BH	TH	MW	LS	DIM
1007-05-....-....				28 cm	32 cm		194 cm	18 W	E27	⊗
1008-05-....-....				28 cm	32 cm		176 cm	18 W	E27	⊗
1017-05-....-....				28 cm	32 cm		176 cm	18 W	E27	⊗

# M.2010

SY0028009 | RECOMMENDED LED LIGHT BULB

SY0026683



SY0026683



05

Fixture/Frame Color



00-00



05-05



06-06



10-10



25-06



30-06



55-55



66-66



75-75

- Color options available for this collection -

Shade Color



2010-....-....-EH-K



2010-....-....-K

PRODUCT NUMBER	L	W	D	∅	SH	BH	TH	MW	LS	DIM
2010-....-K	90cm			41cm	48cm			18w	E27	○
2010-....-EH-K	90cm			41cm	48cm	56cm		18w	E27	○

# M.2011

SY0028009 | RECOMMENDED LED LIGHT BULB



SY0026683



05

Fixture/Frame Color



00-00



05-05



06-06



10-10



25-06



30-06



55-55



66-66



75-75

- Color options available for this collection -

Shade Color



2011-....-....-EV-K-130-2



2011-....-....-K



2011-....-....-K-130-2



2011-....-....-EV-K

PRODUCT NUMBER	L	W	D	∅	SH	BH	TH	MW	LS	DIM
2011-....-....-K	90cm			44,5cm	36cm	40cm		18w	E27	○
2011-....-....-EV-K	90cm			44,5cm	36cm	46cm		18w	E27	○
2011-....-....-K-130-2	90cm	154cm		44,5cm	36cm	40cm		2x18w	E27	○
2011-....-....-EV-K-130-2	90cm	154cm		44,5cm	36cm	46cm		2x18w	E27	○



# M.2011 FLOOR LAMPS

SY0028009 | RECOMMENDED LED LIGHT BULB



SY0026683 |



05

Fixture/Frame Color



00-00



05-05



06-06



10-10



25-06



30-06



55-55



66-66



75-75

- Color options available for this collection -

Shade Color





1011-05-....-....



1012-05-....-....



1010-05-....-....

PRODUCT NUMBER	L	W	D	∅	SH	BH	TH	MW	LS	DIM
1010-05-....-....				46cm	36cm		205cm	18w	E27	⊗
1011-05-....-....				46cm	36cm		208cm	18w	E27	⊗
1012-05-....-....				46cm	36cm		205cm	18w	E27	⊗

# M.2012

SY0028009 | RECOMMENDED LED LIGHT BULB



SY0026683 |



05

Fixture/Frame Color



00-00



05-05



06-06



10-10



25-06



30-06



55-55



66-66



75-75

- Color options available for this collection -

Shade Color



2012-....-....-K



2012-....-....-EV-K

PRODUCT NUMBER	L	W	D	∅	SH	BH	TH	MW	LS	DIM
2012-....-....-K	90cm			58cm	55cm	59cm		18w	E27	○
2012-....-....-EV-K	90cm			58cm	55cm	69cm		18w	E27	○

# M.2013

SY0028006 | RECOMMENDED LED LIGHT BULB

SY0028006 | RECOMMENDED LED LIGHT BULB



SLF023860409 |



05

Fixture/Frame Color

- Color options available for this collection -



....-00



....-05



....-06

Shade Color





2013-....-K-C-160-3



2013-....-K-C



2013-....-K-C-R-100-2



2013-....-K-C-R

PRODUCT NUMBER	L	W	D	∅	SH	BH	TH	MW	LS	DIM
2013-....-K-C	90cm			42cm	21cm	32cm		18w	E27	○
2013-....-K-C-R	90cm			42cm	21cm	47cm		18w	E27	○
2013-....-K-C-160-3	90cm	172cm		42cm	21cm	32cm		3x18w	E27	○
2013-....-K-C-R-100-2	90cm	122cm		42cm	21cm	47cm		2x18w	E27	○

# AIR

Big Ben | M.2011 | Passi

SY0028009 | RECOMMENDED LED LIGHT BULB

SY0026683



SY0026683

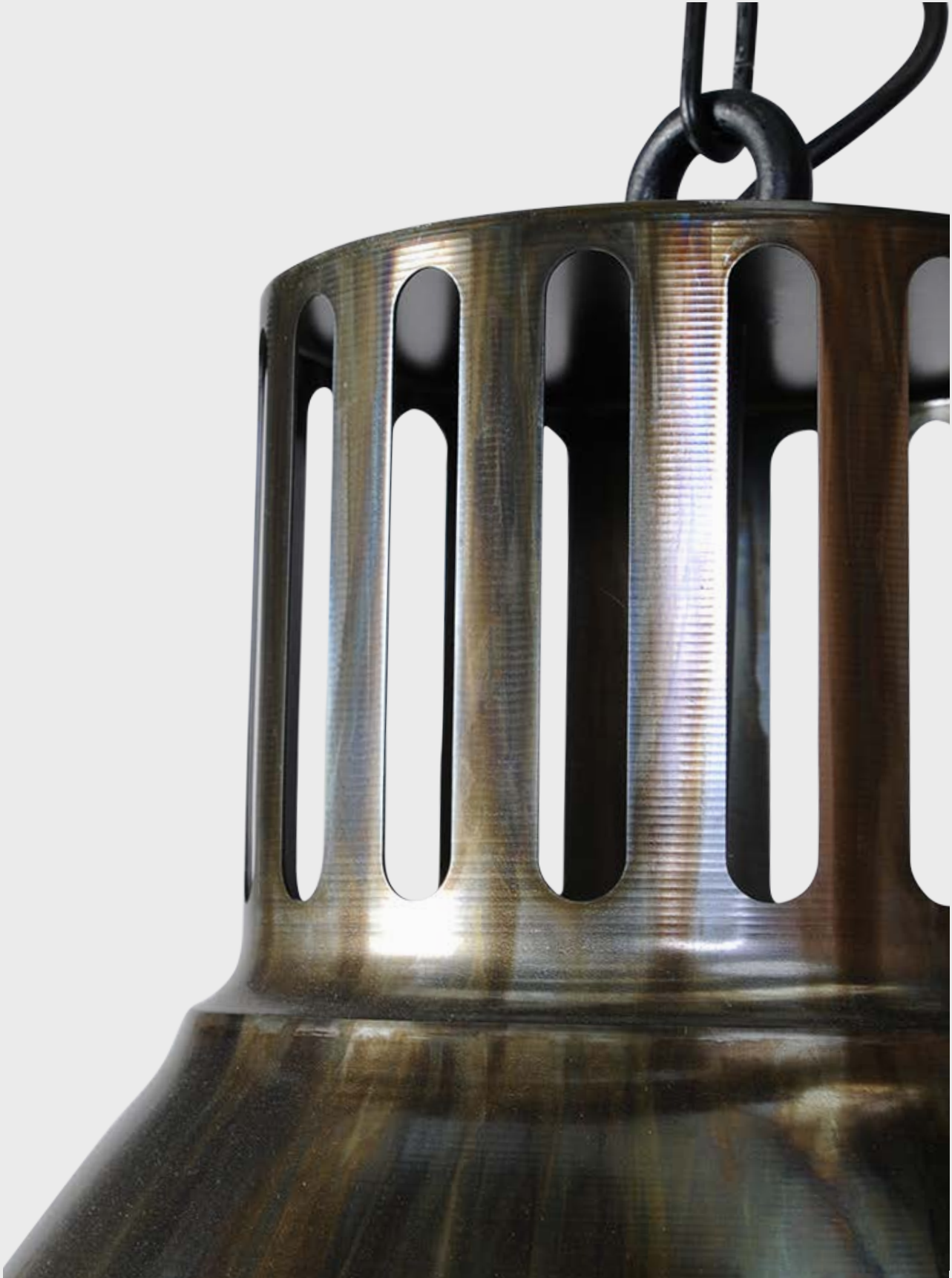

05

Fixture/Frame Color



00-00



05-05



06-06



10-10



66-66

- Color options available for this collection -

Shade Color





1090-05-....-....



2090-....-....-A-K



2970-....-....-A-K



2011-....-....-A-K



4090-05-....-....

PRODUCT NUMBER	L	W	D	Ø	SH	BH	TH	MW	LS	DIM
1090-05-....-....			71cm	19cm	15cm		161cm	18w	E27	⊗
2011-....-....-A-K	90cm			46cm	36cm	40cm		18w	E27	○
2090-....-....-A-K	90cm			33cm	27cm	31cm		18w	E27	○
2970-....-....-A-K	90cm			44cm	43cm	47cm		18w	E27	○
4090-05-....-....			56cm	19cm	15cm		71cm	18w	E27	⊗

# DI PANNA

SY0028009 | RECOMMENDED LED LIGHT BULB



SY0028006



SY0026683



05

Fixture/Frame Color



00-00



05-05



06-06



10-10



25-06



30-06



55-55



66-66



75-75

- Color options available for this collection -

Shade Color



3045-05-....-....



1047-05-....-....



3047-05-....-....



3046-05-....-....

PRODUCT NUMBER	L	W	D	∅	SH	BH	TH	MW	LS	DIM
1047-05-....-....			88cm	48,5cm	27cm		186cm	18w	E27	⊗
3045-05-....-....			33cm	26cm	14cm		42cm	18w	E27	○
3046-05-....-....			123cm	36cm	19cm		49cm	18w	E27	⊗
3047-05-....-....				48,5cm	27cm		45cm	18w	E27	○



2045-.....-S-70-2



1046-05-.....-C



2045-.....-S-100-3

PRODUCT NUMBER	L	W	D	∅	SH	BH	TH	MW	LS	DIM
1046-05-.....-C				36cm	19cm		167cm	18w	E27	⊗
2045-.....-S-70-2	150cm	80cm		26cm	14cm			2x18w	E27	○
2045-.....-S-100-3	150cm	106cm		26cm	14cm			3x18w	E27	○



2046-.....-K-100-2



2046-.....-K



2047-.....-K



2045-.....-S



4045-05-.....

PRODUCT NUMBER	L	W	D	∅	SH	BH	TH	MW	LS	DIM
2045-.....-S	150cm			26cm	14cm			18w	E27	○
2046-.....-K	90cm			36cm	19cm			18w	E27	○
2046-.....-K-100-2	90cm	116cm		36cm	19cm			2x18w	E27	○
2047-.....-K	90cm			48,5cm	27cm			18w	E27	○
4045-05-.....				26cm	14cm		53cm	18w	E27	⊗



# DI PANNA PLUMMING

SY0028009 | RECOMMENDED LED LIGHT BULB



SY0028006



SY0026683



05

00-00

05-05

06-06

10-10

25-06

30-06

55-55

66-66

75-75

Fixture/Frame Color

- Color options available for this collection -

Shade Color



2055-05-....-....-48



2057-05-....-....



2056-05-....-....



3055-05-....-....



4055-05-....-....

PRODUCT NUMBER	L	W	D	∅	SH	BH	TH	MW	LS	DIM
2055-30-....-....	115cm			48,5cm	27cm			18w	E27	○
2056-30-....-....	115cm	137cm		36cm	21cm			2x18w	E27	○
2057-30-....-....	110cm	117cm		26cm	14cm			3x18w	E27	○
3055-30-....-....			33cm	26cm	14cm		25cm	18w	E27	○
4055-30-....-....				26cm	14cm		53cm	18w	E27	⊗

# GRID

SY0028009 | RECOMMENDED LED LIGHT BULB

SY0028006



SY0028006

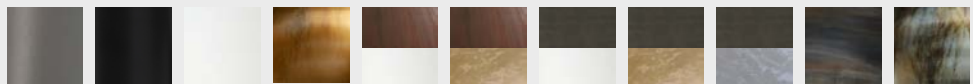

00-00 05-05 06-06 10-10 25-06 25-08 30-06 30-08 30-37 66-66 75-75  
 - Color options available for this collection - Shade Color



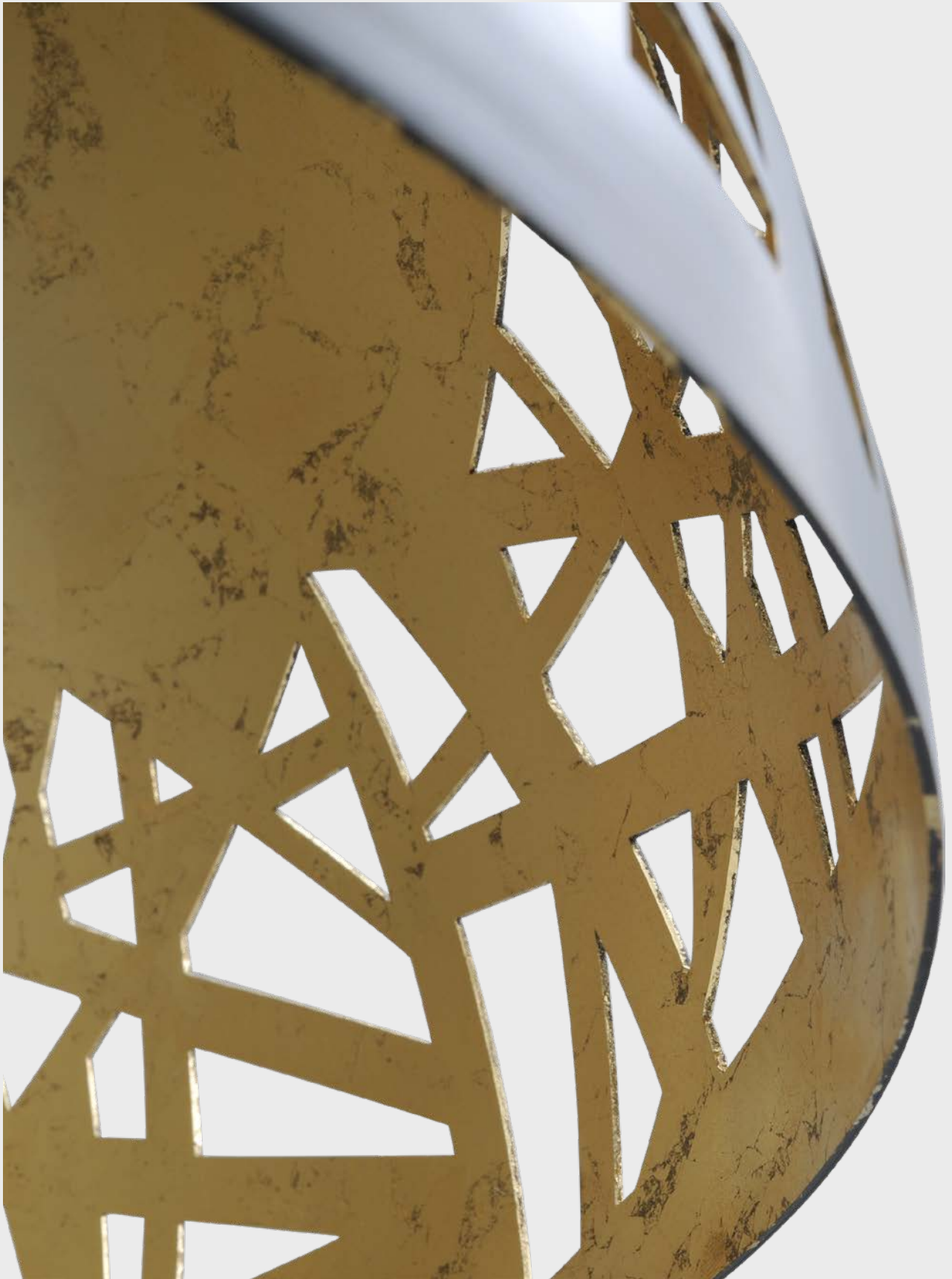

05

Fixture/Frame Color



2504-....-....-S-100-2



2503-....-....-S



2505-....-....-ST



3504-05-....-....

PRODUCT NUMBER	L	W	D	∅	SH	BH	TH	MW	LS	DIM
2503-....-....-S	150cm			30cm	15,5cm			18w	E27	○
2504-....-....-S-100-2	150cm	120cm		40cm	20cm			2x18w	E27	○
2505-....-....-ST	150cm			50cm	26cm			18w	E27	○
3504-....-....			125cm	40cm	26cm		49cm	18w	E27	⊗





5504-....-....

5503-....-....

2506-....-....-ST

2504-....-....-S

1504-....-....

PRODUCT NUMBER	L	W	D	∅	SH	BH	TH	MW	LS	DIM
1504-....-....			82cm	50cm	26cm		185cm	18w	E27	⊗
2504-....-....-S	150cm			40cm	20cm			18w	E27	○
2506-....-....-ST	150cm			60cm	35cm			18w	E27	○
5503-....-....				30cm	15,5cm			18w	E27	○
5504-....-....				40cm	20cm			18w	E27	○





# LARINO

Larino | Larino Bow | Split

SY0028006 | SY0028009 | RECOMMENDED LED LIGHT BULB



SY0028006

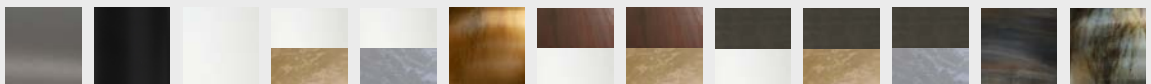

00-00 05-05 06-06 06-08 06-37 10-10 25-06 25-08 30-06 30-08 30-37 66-66 75-75  
- Color options available for this collection - Shade Color





100cm

2202 - .... - .... - / 3ST / K - 3ST



80cm

2201 - .... - .... - / K / 3ST / BL / R-K



60cm

2200 - .... - .... - / K / ST / B-K / BL / R-K



50cm

2197 - .... - .... - / K / ST / B-K / BL / R-K / CU



40cm

2198 - .... - .... - / S / K / ST / B-K / BL / R-K / CU



30cm

2199 - .... - .... - / S / K / ST / B / BL / R-K / CU

PRODUCT NUMBER	L	W	D	∅	SH	BH	TH	MW	LS	DIM
2199-.....				30cm	15,5cm			18w	E27	○
2198-.....				40cm	20cm			18w	E27	○
2197-.....				50cm	26cm			18w	E27	○
2200-.....				60cm	35cm			18w	E27	○
2201-.....				80cm	38cm			18w	E27	○
2202-.....				100cm	49cm			18w	E27	○





1105- .... - ....



1104- .... - ....



5199- .... - ....-B



5198 - .... - ....

PRODUCT NUMBER	L	W	D	∅	SH	BH	TH	MW	LS	DIM
1104-....-....				40cm	20cm		163cm	18w	E27	⊗
1105-....-....				50cm	26cm		173cm	18w	E27	⊗
5199-....-....-B				30cm	15,5cm		30cm	18w	E27	○
5198-....-....				40cm	20cm		25cm	18w	E27	○



1205-40-....-....



3198-....-....



4198-....-....



4197-....-....

PRODUCT NUMBER	L	W	D	∅	SH	BH	TH	MW	LS	DIM
1205-40-....-....			82cm	40cm	20cm		186cm	18w	E27	⊗
3198-....-....			125cm	40cm	20cm		49cm	18w	E27	⊗
4197-....-....				50cm	26cm	60cm		18w	E27	⊗
4198-....-....				40cm	20cm		44cm	18w	E27	⊗



2200-.....-K



2197-.....-ST



2201-.....-K

PRODUCT NUMBER	L	W	D	∅	SH	BH	TH	MW	LS	DIM
2197-.....-ST	150cm			50cm	26cm	28cm		18w	E27	○
2200-.....-K	90cm			60cm	35cm	39cm		18w	E27	○
2201-.....-K	90cm			80cm	38cm	42cm		18w	E27	○



PRODUCT NUMBER	L	W	D	∅	SH	BH	TH	MW	LS	DIM
2197-....-....-R-K	90cm			50cm	26cm	50cm		18w	E27	○
2199-....-....-CU-S	150cm			30cm	15,5cm	27,5cm		18w	E27	○
2200-....-....-B	90cm			60cm	35cm	55cm		18w	E27	○



2202-....-....-K-3ST



2201-....-....-BL

PRODUCT NUMBER	L	W	D	∅	SH	BH	TH	MW	LS	DIM
2201-....-....-BL	90cm			80cm	38cm	66cm		18w	E27	○
2202-....-....-K-3xST	90cm			100cm	49cm	43cm		18w	E27	○



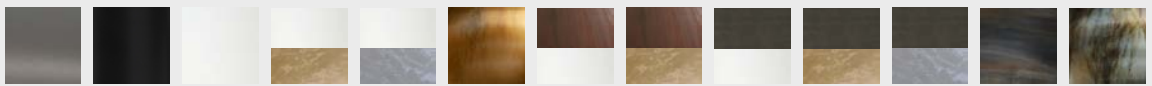

00-00 05-05 06-06 06-08 06-37 10-10 25-06 25-08 30-06 30-08 30-37 66-66 75-75  
 Color options available for this collection



2200-....-....-K-160-2



4199 - .... - ....-B

PRODUCT NUMBER	L	W	D	∅	SH	BH	TH	MW	LS	DIM
2200-....-....-K-160-2	90cm	190cm		60cm	35cm	39cm		2x18w	E27	○
4199-....-....-B				30cm	15,5cm		80cm	18w	E27	⊗



2197-.....-K-130-2



2198-.....-K-160-3

PRODUCT NUMBER	L	W	D	∅	SH	BH	TH	MW	LS	DIM
2197-.....-K-130-2	90cm	160cm		50cm	26cm	30cm		2x18w	E27	○
2198-.....-K-160-3	90cm	170cm		40cm	20cm	24cm		3x18w	E27	○



2198-....-....-S-100-2



2199-....-....-S-130-3

PRODUCT NUMBER	L	W	D	∅	SH	BH	TH	MW	LS	DIM
2198-....-....-S-100-2	150cm	120cm		40cm	20cm	20cm		2x18w	E27	○
2199-....-....-S-130-3	150cm	140cm		30cm	15,5cm	15,5cm		3x18w	E27	○







2198-....-....-CU-K-100-2



4198-....-....-B

PRODUCT NUMBER	L	W	D	∅	SH	BH	TH	MW	LS	DIM
2198-....-....-CU-K-100-2	90cm	120cm		40cm	20cm	32cm		2x18w	E27	○
4198-....-....-B				40cm	20cm		65cm	18w	E27	⊗



2201-....-....-3ST



2197-....-....-K



4197-....-....-B

PRODUCT NUMBER	L	W	D	∅	SH	BH	TH	MW	LS	DIM
2197-....-....-K	90cm	11cm		50cm	26cm	30cm		18w	E27	○
2201-....-....-3ST	150cm	11cm		80cm	38cm	39cm		18w	E27	○
4197-....-....-B				50cm	26cm		80cm	18w	E27	⊗

SY0029001 | SY0029003 | RECOMMENDED LED LIGHT BULB



SY0029001 |







# PETROL

SY0028006 | SLF023860409 | RECOMMENDED LED LIGHT BULB



SY0028006



05

Fixture/Frame Color

- Color options available for this collection -



.....-10

.....-65

Shade Color







2167- ....



PRODUCT NUMBER	L	W	D	∅	SH	BH	TH	MW	LS	DIM
2167-....	90cm	140cm	32cm			38cm		3x18w	E27	○



2166- ....



2165- ....

PRODUCT NUMBER	L	W	D	∅	SH	BH	TH	MW	LS	DIM
2165-....	90cm	90cm	32cm			38cm		2x18w	E27	○
2166-....	90cm	110cm	32cm			44cm		3x18w	E27	○

# PRATO

SY0026683 | SY0028006 | SY0028009 | RECOMMENDED LED LIGHT BULB



05

Fixture/Frame Color



00-00



05-05



06-06



10-10



25-25



30-30



55-55



66-66



75-75

- Color options available for this collection -

Shade Color





3545-05-....

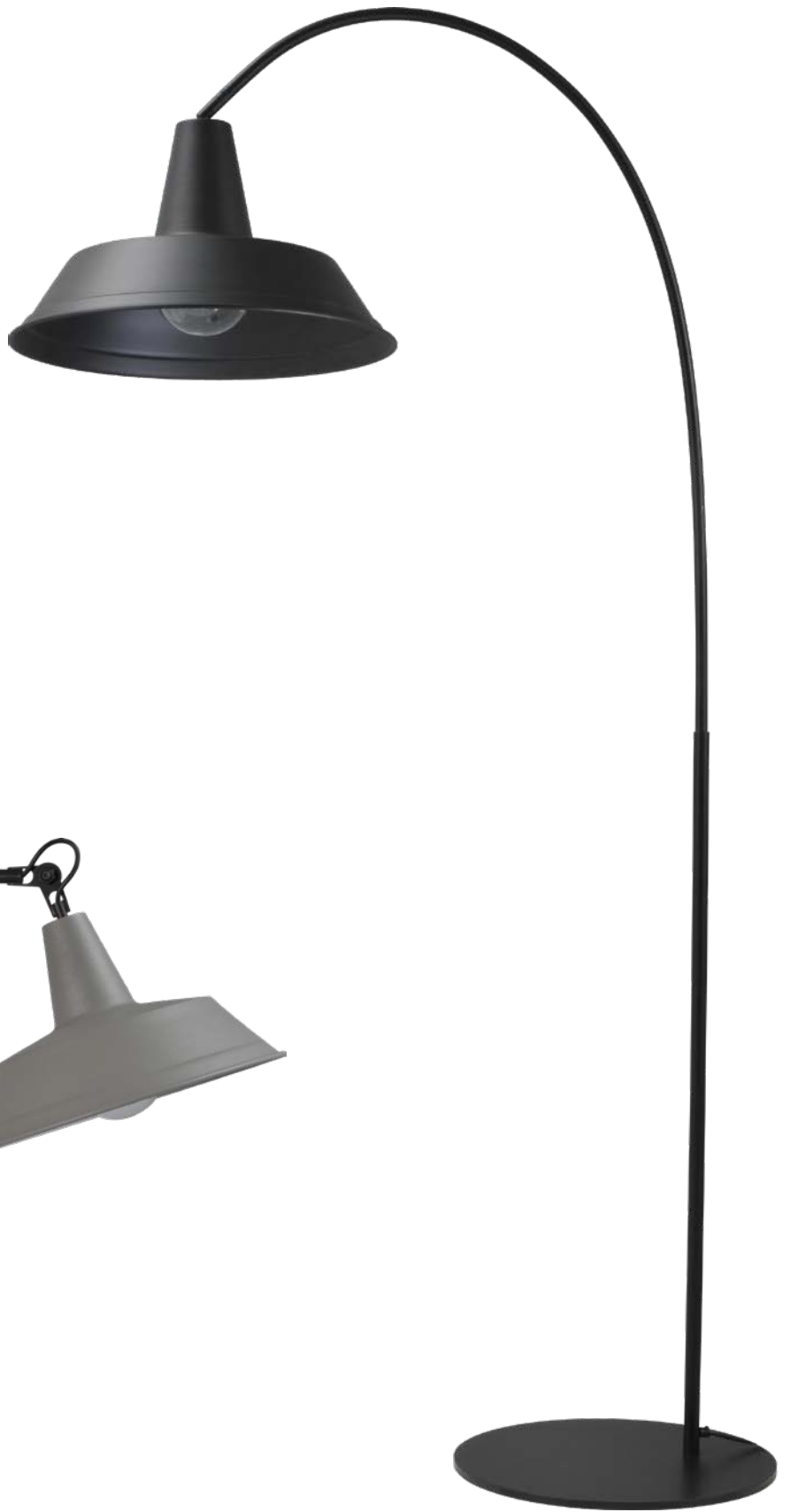

1547-05-....



3546-05-....

PRODUCT NUMBER	L	W	D	∅	SH	BH	TH	MW	LS	DIM
1547-05-....			86cm	45cm	26cm		186cm	18w	E27	⊗
3545-05-....			32,5cm	25cm	14cm		42cm	18w	E27	○
3546-05-....			122,5cm	35cm	21cm		49cm	18w	E27	⊗





2545-....-S-70-2



2547-....-S



2545-....-S-100-3

PRODUCT NUMBER	L	W	D	∅	SH	BH	TH	MW	LS	DIM
2545-....-S-70-2	150cm	79cm		25cm	14cm			2x18w	E27	○
2545-....-S-100-3	150cm	105cm		25cm	14cm			3x18w	E27	○
2547-....-S	150cm			45cm	26cm			18w	E27	○



2545-....-S



2547-....-S-130-2



2546-....-S



4037-05-....

PRODUCT NUMBER	L	W	D	∅	SH	BH	TH	MW	LS	DIM
2545-....-S	150cm			25cm	14cm			18w	E27	○
2546-....-S	150cm			35cm	21cm			18w	E27	○
2547-....-S-130-2	150cm	155cm		45cm	26cm			2x18w	E27	○
4037-05-....				25cm	14cm		53cm	18w	E27	⊗

# PRATO 'PLUMMING'

SY0028009 | RECOMMENDED LED LIGHT BULB  
 SY0028006  
 SY0026683



05

Fixture/Frame Color



00-00



05-05



06-06



10-10



25-25



30-30



55-55



66-66



75-75

- Color options available for this collection -

Shade Color



2035-05-....



2037-05-....



2036-05-....



3035-05-....



4035-05-....

PRODUCT NUMBER	L	W	D	∅	SH	BH	TH	MW	LS	DIM
2035-05-....	115cm			45cm	26cm			18w	E27	○
2036-05-....	115cm	137cm		35cm	21cm			2x18w	E27	○
2037-05-....	110cm	115cm		25cm	14cm			3x18w	E27	○
3035-05-....			33cm	25cm	14cm	25cm		18w	E27	○
4035-05-....				25cm	14cm	53cm		18w	E27	⊗



# PRATO XL+XXL

SY0028009 | RECOMMENDED LED LIGHT BULB



SY0026683 |



05

Fixture/Frame Color



00-00



05-05



06-06



37-37

- Color options available for this collection -

Shade Color





2014-....-....-K



2015-....-....-K



2015-....-....-C-K

PRODUCT NUMBER	L	W	D	∅	SH	BH	TH	MW	LS	DIM
2014-....	90cm			55cm	30cm	34cm		18w	E27	○
2015-....	90cm			67cm	35cm	39cm		18w	E27	○
2015-....-C	90cm			67cm	35cm	44cm		18w	E27	○

# CONCEPTO

COLLECTION

**master**light

# INDEX



Arch  
080/083

---



Aton  
084/087

---



Boris  
088/089

---



Boris XXL  
090/091

---



Cage  
092/095

---



Camillo  
096/097

---



Casco  
098/101

---



Cesto  
102/105

---



Cross  
106/109

---



Cup  
110/113

---



Eifel  
114/117

---

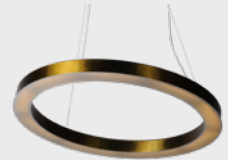

Esmee  
118/123

---



Globo  
124/127

---



Lett  
128/139

---



Octo  
140/143

---



Ogiva  
144/145

---



Pineapple  
146/149

---



Quinto  
150/159

---



Run  
160/163

---



Tessi  
164/169

---



Trip  
170/177

---



Tube  
178/181

---



Venus  
182/183

---



Zyan  
184/187

---

# ARCH

SY0026683 | RECOMMENDED LED LIGHT BULB



05

Fixture/Frame Color



....-20 ....-82 ....-01

- Color options available for this collection -

Shade Color

'Arch' Shade are supplied with an acrylic disc



Camelot shade color  
20



Camelot shade color  
82



Camelot shade color  
01



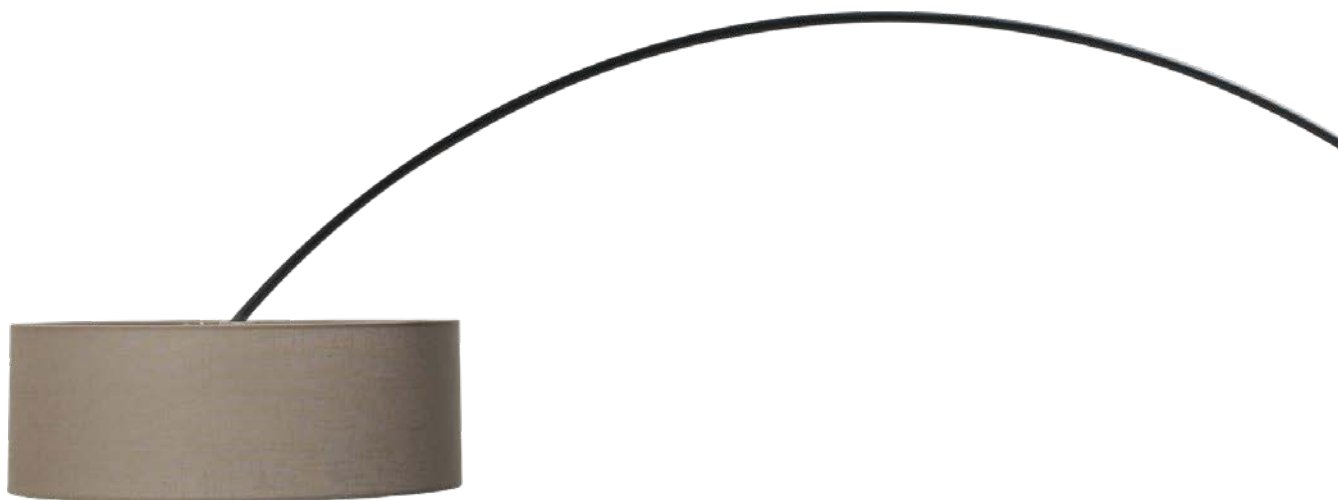

1206-05-6560-....-55

PRODUCT NUMBER	L	W	D	∅	SH	BH	TH		MW	LS	DIM
1206-05-6560-....-55			217 cm	55 cm	20 cm		211 cm		18 W	E27	⊗

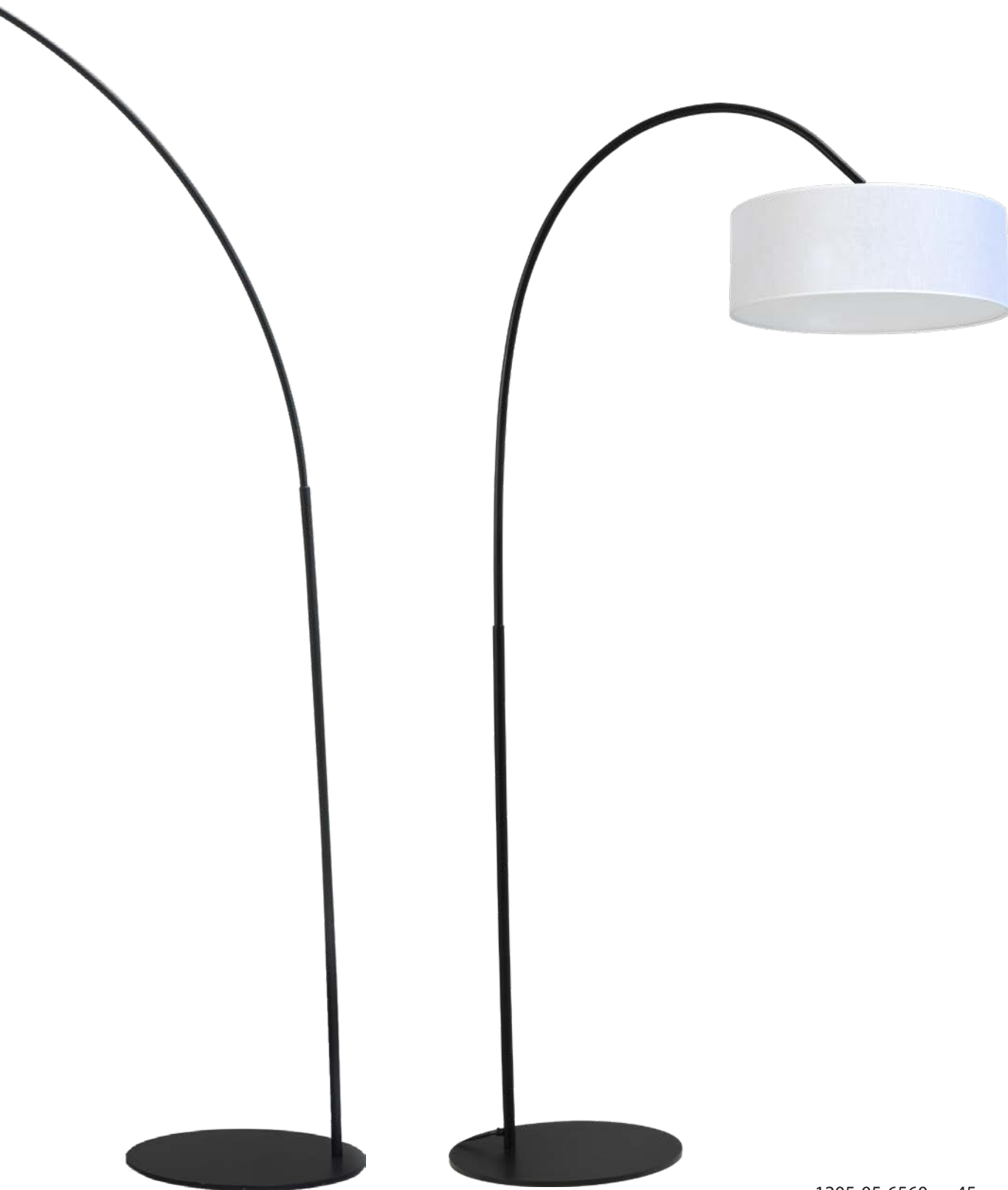

1205-05-6560-....-45

PRODUCT NUMBER	L	W	D	∅	SH	BH	TH	MW	LS	DIM
1205-05-6560-....-45			80 cm	45 cm	20 cm		183 cm	18 W	E27	⊗

# ATON

SLF023981405 | SLF023981305 | SLF023981205 | SLF023981105 | RECOMMENDED LED LIGHT BULB

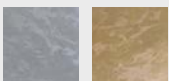

....-37 ....-02  
Fixture/Frame Color

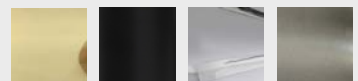

02-.... 05-.... 07-.... 37-....  
- Socket cover / Shade Color

- Color options available for this collection -



SLF023981105



SLF023981205



SLF023981305



SLF023981405

PRODUCT NUMBER	L	W	D	∅	SH	BH	TH	LW	LM	K	LS	DIM
LF023981105				16.5 cm	30 cm		84 cm	4 w	250	2000K	E27	⊗
LF023981205				20 cm	29 cm		84 cm	4 w	250	2000K	E27	⊗
LF023981305				18 cm	37 cm		84 cm	4 w	250	2000K	E27	⊗
LF023981405				12 cm	44 cm		84 cm	4 w	250	2000K	E27	⊗

Glass decorative LED bulbs . Schiefer professional lighting



2240-.....-60-8

PRODUCT NUMBER	L	W	D	∅	SH	BH	TH	MW	LS	DIM
2240-.....-60-8	400cm	60cm	60cm					8x18w	E27	○





2240-.....-90-12

PRODUCT NUMBER	L	W	D	∅	SH	BH	TH	MW	LS	DIM
2240-.....-90-12	400cm	90cm	90cm					12x18w	E27	○

# BORIS

SY0029001 | RECOMMENDED LED LIGHT BULB

SY0026683



SY0026683



05

Fixture/Frame Color



....-00



....-05



....-06



....-56

- Color options available for this collection -

Shade Color



PRODUCT NUMBER	L	W	D	∅	SH	BH	TH	MW	LS	DIM
2020-05-....-100-3	150cm	100cm		14,5cm	19,5cm			3x18w	E27	○
2020-05-....	150cm			14,5cm	19,5cm			18w	E27	○
1020-05-....			71cm	14,5cm	19,5cm		161cm	18w	E27	⊗
4020-05-....			56cm	14,5cm	19,5cm		71cm	18w	E27	⊗
3020-05-....			28cm	14,5cm	19,5cm		22cm	18w	E27	○



# BORIS XXL

SY0029003 | RECOMMENDED LED LIGHT BULB



SY0026683 |



“Lighting is a composition in space and time”.



00-.... 05-.... 06-....  
Fixture/Frame Color

- Color options available for this collection -



....-00 ....-05 ....-06  
Shade Color



1025-....-....



2025-05-....



2025-05-....



1025-....-....

PRODUCT NUMBER	L	W	D	∅	SH	BH	TH	MW	LS	DIM
2025-05-....	150cm			27,5cm	36cm			18W	E27	○
1025-....-....				27,5cm	36cm		186cm	18W	E27	⊗



# CAGE

SY0028002 | RECOMMENDED LED LIGHT BULB



05

Fixture/Frame Color



....-00



....-05



....-06

- Color options available for this collection -

Shade Color

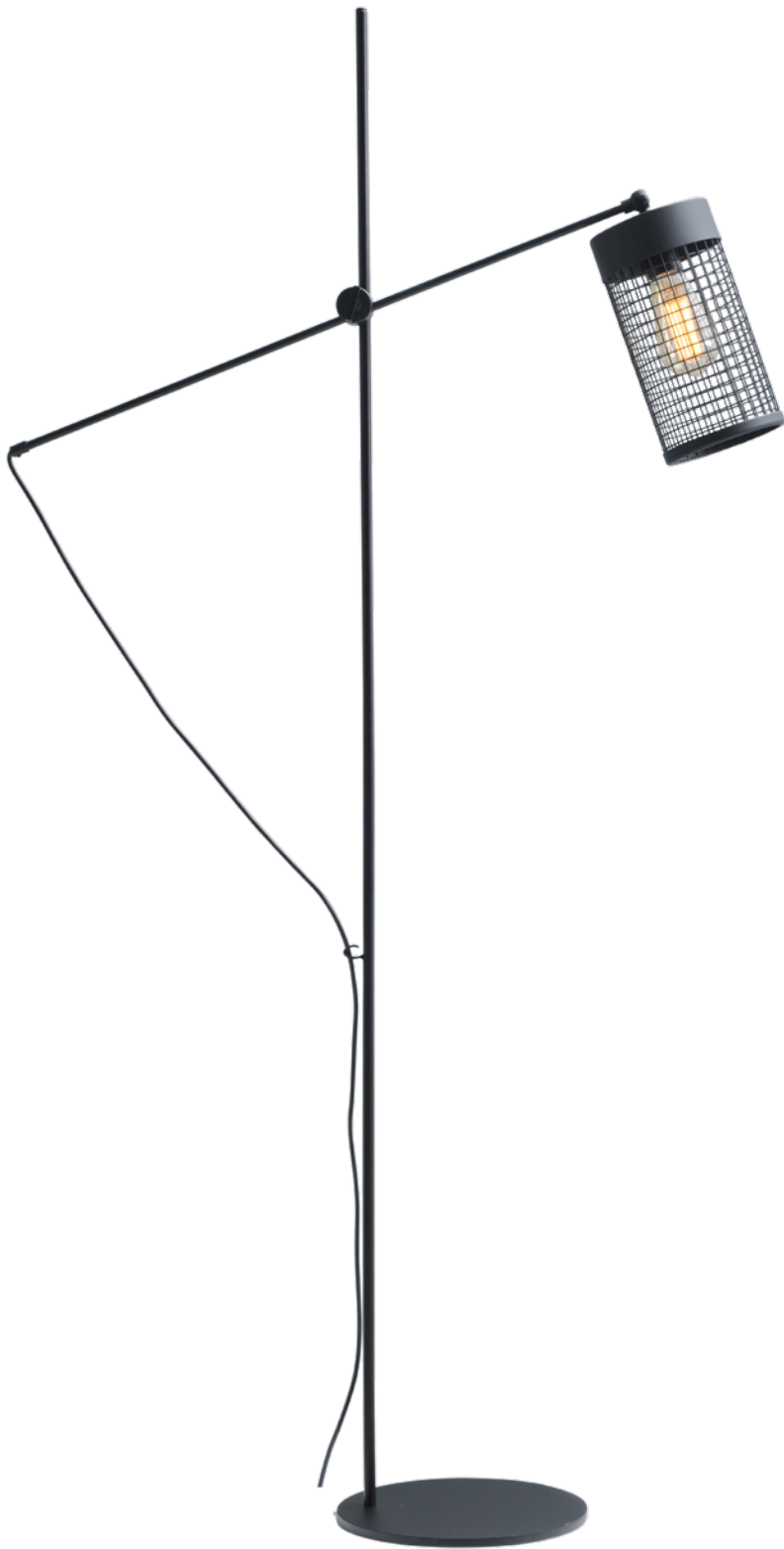

1420-05-....



2422-05-....-S-35-3

PRODUCT NUMBER	L	W	D	∅	SH	BH	TH	MW	LS	DIM
1420-05-....			71cm	13cm	25cm		161cm	18w	E27	⊗
2422-05-....-35-3	250cm	35cm		13cm	25cm			3x18w	E27	○



1421-05-....



2421-05-....-S-100-3



4421-05-....

PRODUCT NUMBER	L	W	D	∅	SH	BH	TH	MW	LS	DIM
1421-05-....	150cm	100cm		13cm	25cm			3x18w	E27	⊗
2421-05-....-100-3				13cm	25cm		155cm	18w	E27	○
4421-05-....				13cm	25cm		25cm	18w	E27	⊗



2421-05-....-S-130-4



4420-05-....

PRODUCT NUMBER	L	W	D	∅	SH	BH	TH	MW	LS	DIM
2421-05-....-130-4	150cm	130cm		13cm	25cm			4x18w	E27	○
4420-05-....			56cm	13cm	25cm		71cm	18w	E27	⊗

# CAMILLO

SY0029003 | RECOMMENDED LED LIGHT BULB



SY0029001 |



SY0026683 |



05

Fixture/Frame Color



....-00



....-05



....-06



....-08

- Color options available for this collection -

Shade Color





2756-....-S

2755-....-S-100-3

2757-....-ST

2758-....-ST

2755-....-S

PRODUCT NUMBER	L	W	D	∅	SH	BH	TH	MW	LS	DIM
2755-....-S	150cm			16cm	21cm			18w	E27	○
2755-....-S-100-3	150cm	100cm		16cm	21cm			3x18w	E27	○
2756-....-S	150cm			26cm	32cm			18w	E27	○
2757-....-ST	150cm			33cm	42cm			18w	E27	○
2758-....-ST	150cm			40cm	50cm			18w	E27	○

# CASCO

SY0029003 | RECOMMENDED LED LIGHT BULB



SY0029001 |



SY0026683 |



37

Fixture/Frame Color

- Color options available for this collection -



....-00



....-05



....-06



....-37

Shade Color



2733-....-S

2731-....-S

2732-....-S

2735-....-S

2730-....-S

PRODUCT NUMBER	L	W	D	∅	SH	BH	TH	MW	LS	DIM
2730 -....	150cm			30cm	15cm			18w	E27	○
2731 -....	150cm			35cm	18cm			18w	E27	○
2732 -....	150cm			45cm	21cm			18w	E27	○
2735 -....	150cm			60cm	30cm			18w	E27	○
2733 -....	150cm			72cm	37cm			18w	E27	○



2730-....-S-130-3



4731-....

PRODUCT NUMBER	L	W	D	∅	SH	BH	TH	MW	LS	DIM
2730-....-130-3	150cm	140cm		30cm	15cm			3x18w	E27	○
4731-....				35cm	18cm		40cm	18w	E27	⊗



2732-....-S-130-2

2731-....-S-100-2



4730-....

PRODUCT NUMBER	L	W	D	∅	SH	BH	TH	MW	LS	DIM
2731-....-100-2	150cm	115cm		35cm	18cm			2x18w	E27	○
2732-....-130-2	150cm	155cm		45cm	21cm			2x18w	E27	○
4730-....				30cm	15cm		40cm	18w	E27	⊗



# CESTO

SY0028009 | RECOMMENDED LED LIGHT BULB  
 SY0028006 |  
 SY0028002 |



05

Fixture/Frame Color



....-00

....-05

....-06

....-08

- Color options available for this collection -

Shade Color



2065-....-30-130-3



1065-05-....-30

PRODUCT NUMBER	L	W	D	∅	SH	BH	TH	MW	LS	DIM
1065-05-30				28cm	40cm	40cm	171cm	18w	E27	⊗
2065-....-30-130-3	150cm	138cm		28cm	40cm	40cm		3x18w	E27	○



2065-....-30



2065-....-42



2065-....-62

PRODUCT NUMBER	L	W	D	∅	SH	BH	TH	MW	LS	DIM
2065-....-62	150cm			67cm	71cm	71cm		18w	E27	○
2065-....-42	150cm			44cm	58cm	58cm		18w	E27	○
2065-....-30	150cm			28cm	40cm	40cm		18w	E27	○





# CROSS

Woman | Rectangle | Triangle

SY0026683 | RECOMMENDED LED LIGHT BULB



00-.... 05-.... 06-....  
Fixture/Frame Color

- Color options available for this collection -



....-11 ....-20 ....-83  
Shade Color





1562-....-6390-....-52



1561-....-6390-....-52



1560-....-6390-....-52

PRODUCT NUMBER	L	W	D	∅	SH	BH	TH	MW	LS	DIM
1560-....-6390-....-52				52cm	25cm	134cm	159cm	18w	E27	⊗
1561-....-6390-....-52				52cm	25cm	136cm	161cm	18w	E27	⊗
1562-....-6390-....-52				52cm	25cm	135cm	160cm	18w	E27	⊗

CUSTOM MADE - ON REQUEST

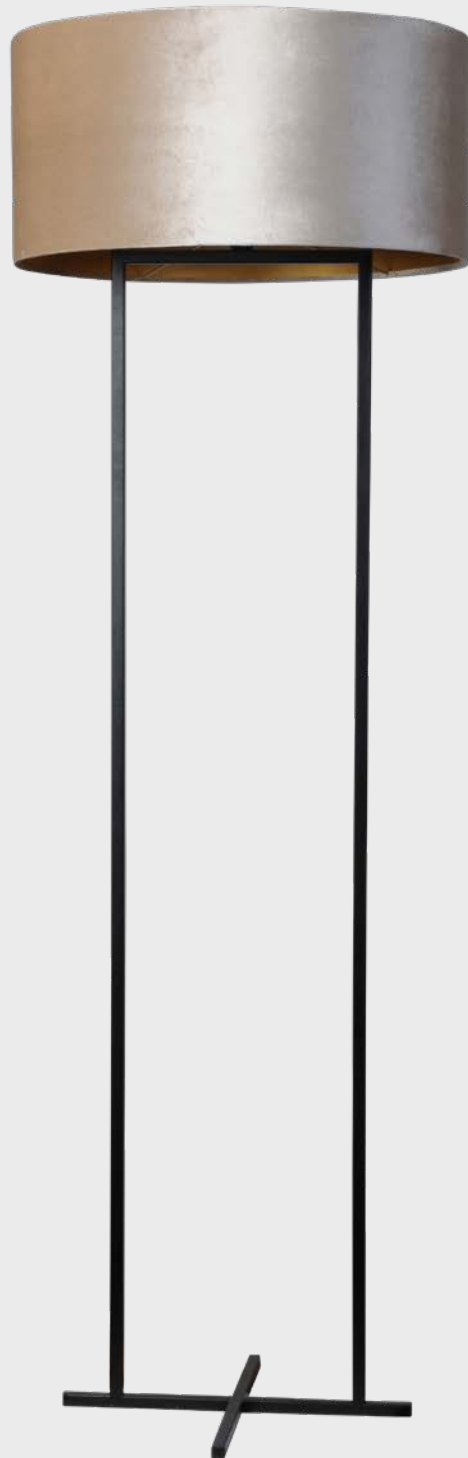

Velvet shade color options - inside shade gold

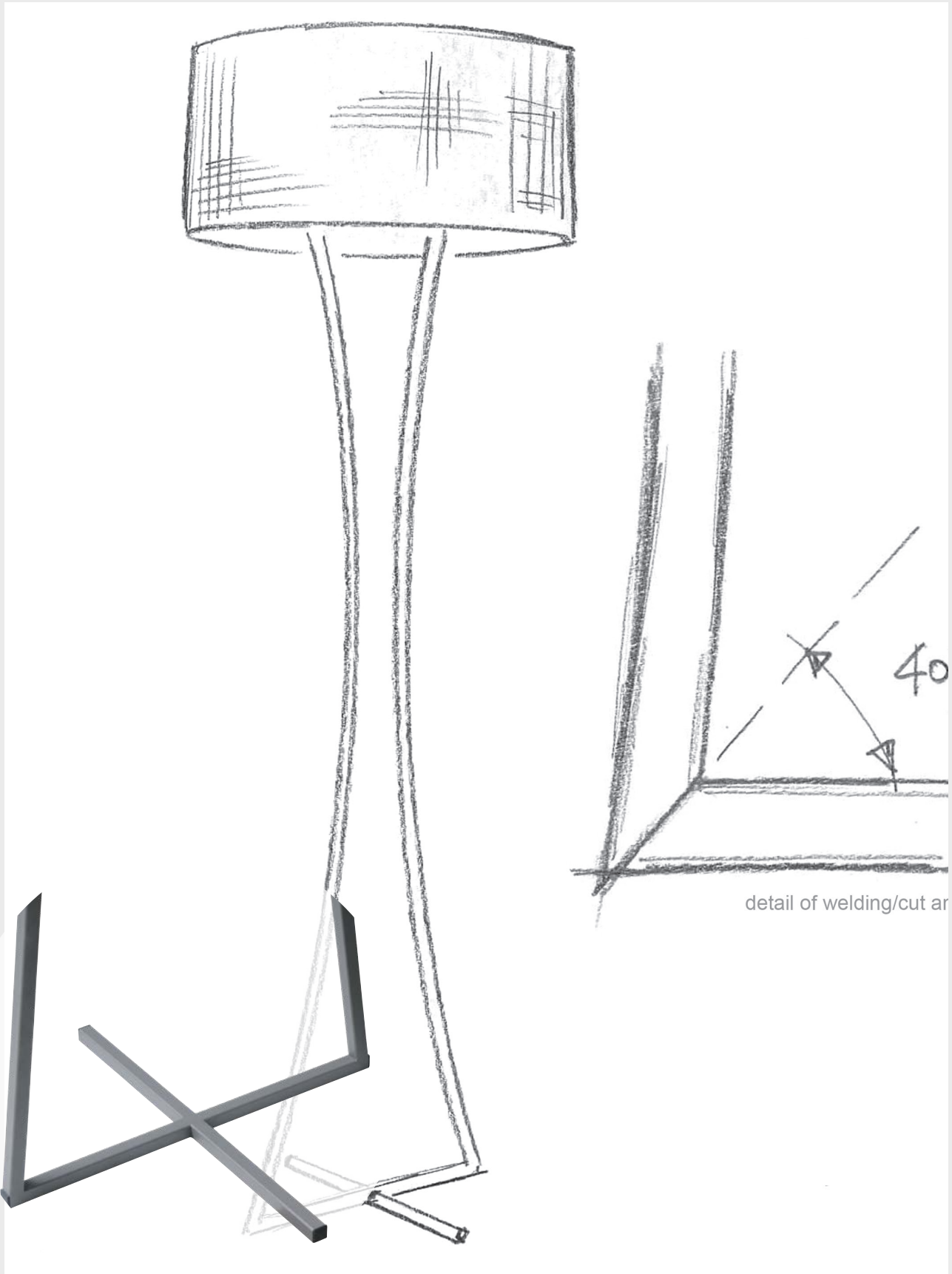

# CUP

SY0028002 | RECOMMENDED LED LIGHT BULB



05

Fixture/Frame Color

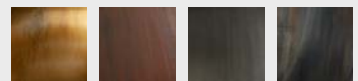

....-10 ....-25 ....-30 ....-66

Shade Color

- Color options available for this collection -



1070-05-....



4070-05-....

PRODUCT NUMBER	L	W	D	∅	SH	BH	TH	MW	LS	DIM
1070-05-....			71cm	15cm	19,5cm		161cm	18w	E27	⊗
4070-05-....			56cm	15cm	19,5cm		71cm	18w	E27	⊗





5070-....

2071-....

PRODUCT NUMBER	L	W	D	∅	SH	BH	TH	MW	LS	DIM
2071-....	70-140cm	148cm		15cm	19,5cm	47cm		8x18w	E27	○
5070-....	70-140cm	126cm		15cm	19,5cm	47cm		6x18w	E27	○



2070-....

PRODUCT NUMBER	L	W	D	∅	SH	BH	TH	MW	LS	DIM
2070-....	70-140cm	126cm		15cm	19,5cm	47cm		6x18w	E27	○

# EIFEL

SY0026683 | RECOMMENDED LED LIGHT BULB

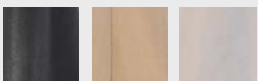

05-.... 15-.... 06-....  
Fixture/Frame Color

- Color options available for this collection -



....-11 ....-20 ....-83  
Shade Color



1750-....-6390-....-52

PRODUCT NUMBER	L	W	D	∅	SH	BH	TH	MW	LS	DIM
1750-....-6390-....-52				52cm	25cm	138cm	164cm	18w	E27	⊗



1750-....-6390-....-52



4750-....-6390-....-37

PRODUCT NUMBER	L	W	D	∅	SH	BH	TH		MW	LS	DIM
1750-....-6390-....-52				52cm	25cm	138cm	164cm		18w	E27	⊗
4750-....-6390-....-37				37cm	25cm	55cm	79cm		18w	E27	⊗



CUSTOM MADE - ON REQUEST



1750-....-6390-....-52



Velvet shade color options - inside shade gold

# ESMEE

LED 5 YEARS WARRANTY



05

Fixture/Frame Color



....-00



....-05



....-06



....-08



....-10



....-25



....-30



....-37



....-66



....-70

- Color options available for this collection -

Shade Color



2795-....-100-27-TR

2795-....-70-27K-TR

PRODUCT NUMBER	L	W	D	∅	SH	BH	TH	LW	LM	K	LS	DIM
2795-....-70-27K-TR	150cm			70cm	7cm			45w	5500	2700k		○
2795-....-100-27K-TR	150cm			100cm	7cm			60w	7350	2700k		○

ALSO AVAILABLE IN DIM TO WARM 



2795-....-50-27K-TR



2795-....-100-27K-TR

PRODUCT NUMBER	L	W	D	∅	SH	BH	TH	LW	LM	K	LS	DIM
2795-....-50-27K-TR	150cm			50cm	7cm			25w	3000	2700k		○
2795-....-100-27K-TR	150cm			100cm	7cm			60w	7350	2700k		○

ALSO AVAILABLE IN DIM TO WARM 



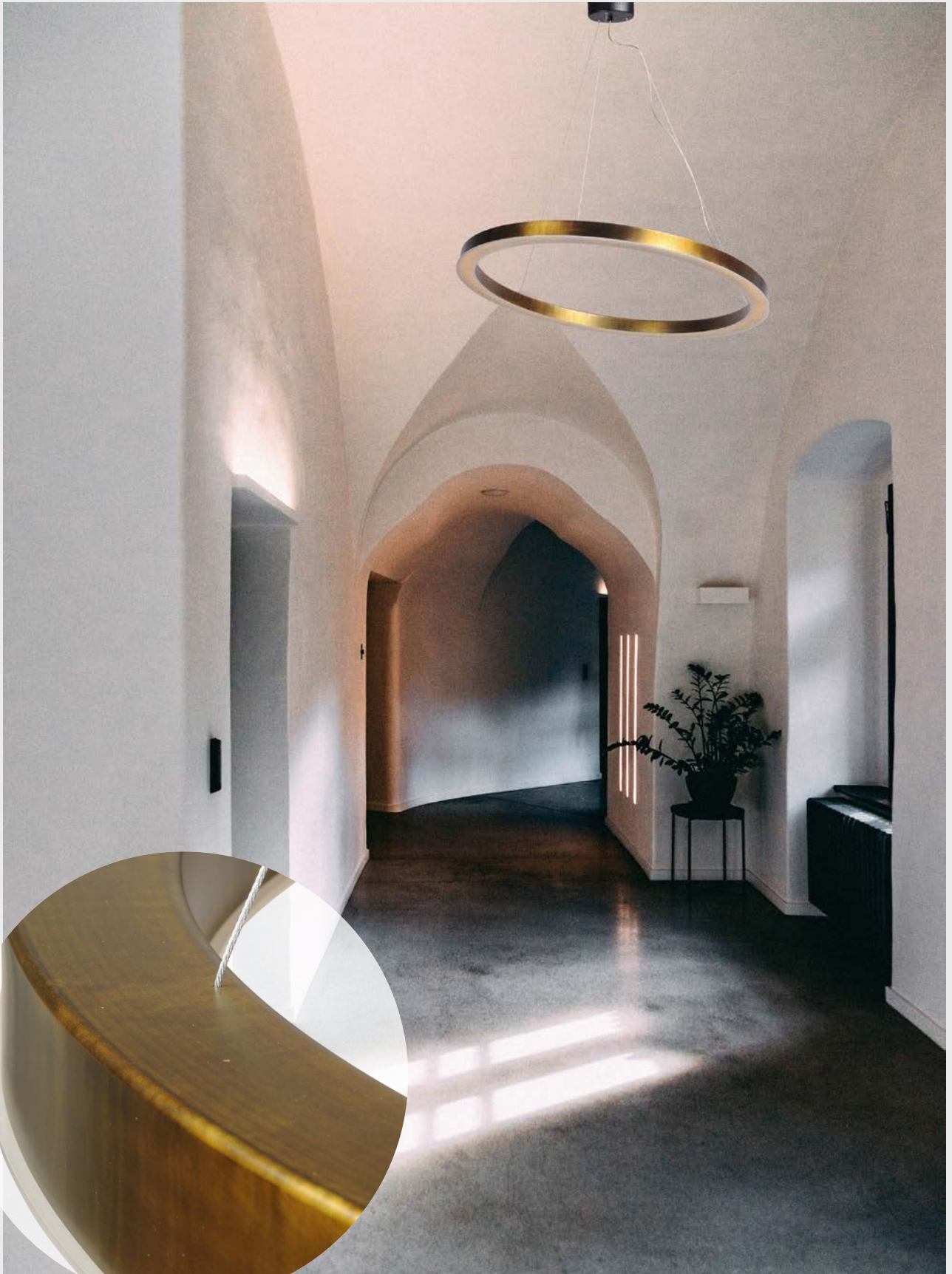



CUSTOM MADE - ON REQUEST



PRODUCT NUMBER	L	W	D	∅	SH	BH	TH	LW	LM	K	LS	DIM
2795-....-50-27K-TR-SP				50cm	5cm			25w	3000	2700k		○
2795-....-70-27K-TR-SP				70cm	5cm			45w	5500	2700k		○
2795-....-100-27K-TR-SP				100cm	5cm			60w	7350	2700k		○

ALSO AVAILABLE IN DIM TO WARM 



# G L O B O

SY0029003 | RECOMMENDED LED LIGHT BULB  
SY0029001  
SY0026683



37

Fixture/Frame Color

- Color options available for this collection -



....-00

....-05

....-06

....-37

Shade Color



2811-....-100-2

PRODUCT NUMBER	L	W	D	∅	SH	BH	TH	MW	LS	DIM
2811-....-100-2	150cm	120cm		40cm	28cm			2x18w	E27	○



2810-....



2811-....



2812-....

PRODUCT NUMBER	L	W	D	∅	SH	BH	TH	MW	LS	DIM
2810-....	150cm			20cm		15cm		18W	E27	○
2811-....	150cm			40cm		28cm		18W	E27	○
2812-....	150cm			50cm		37cm		18W	E27	○





2810-....-130-3

PRODUCT NUMBER	L	W	D	∅	SH	BH	TH	MW	LS	DIM
2810-....-130-3	150cm	130cm		20cm	15cm			3x18w	E27	○

# LETT

SLF023860409 | RECOMMENDED LED LIGHT BULB



02-.... 05-....

Fixture/Frame Color

- Color options available for this collection -

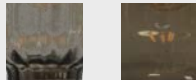

....-05 ....-05GL

Shade Color



62160-05-20



62160-05-28



62155-05



62160-05GL-20



62160-05GL-28



62155-05GL

PRODUCT NUMBER	L	W	D	∅	SH	BH	TH	LS	DIM
62160-05-20				20cm	22,5cm			E27	
62160-05-28				28cm	30cm			E27	
62155-05				15cm	32,5cm			E27	
62160-05GL-20				20cm	22,5cm			E27	
62160-05GL-28				28cm	30cm			E27	
62155-05GL				15cm	32,5cm			E27	



71161-05  
+  
621.....-.....



75160-05  
+  
621.....-.....



75160-05  
+  
621.....-.....

PRODUCT NUMBER	L	W	D	∅	SH	BH	TH	MW	LS	DIM
71161-05			35cm				165cm	18w	E27	⊗
75160-05		10cm					15cm	18w	E27	○

- all measurements exclude glasses -



72160-....

+

621....-....-....



72162-....-50-5

+

+ 621....-....-....

+ 621....-....-....

+ 621....-....-....

+ 621....-....-....

+ 621....-....-....

Glass Number(s)  
page 129

PRODUCT NUMBER	L	W	D	∅	SH	BH	TH	MW	LS	DIM
72160-....	150cm							18w	E27	○
72162-....-50-5	350cm	50cm	50cm					5x18w	E27	○

- all measurements exclude glasses -





72161-....-130-25-6

+  
 + 621-....-....-....  
 + 621-....-....-....  
 + 621-....-....-....  
 + 621-....-....-....  
 + 621-....-....-....  
 + 621-....-....-....

Glass Number(s)  
 page 129

74160-05

+  
 621-....-....-....



PRODUCT NUMBER	L	W	D	∅	SH	BH	TH	MW	LS	DIM
72161-....-130-25-6	150cm	130cm	25cm					6x18w	E27	○
74160-05		10cm					15cm	18w	E27	⊗

- all measurements exclude glasses -





72161-....-130-3

+

621.....-.....

621.....-.....

621.....-.....

74160-05

+

621.....-.....



PRODUCT NUMBER	L	W	D	∅	SH	BH	TH	MW	LS	DIM
72161-....-130-3	150cm	130cm						3x18w	E27	○
74160-05			10cm				15cm	18w	E27	⊗

- all measurements exclude glasses -



72160-....  
+  
621....-....-....



72161-....-100-2  
+  
621....-....-....  
621....-....-....

Glass Number(s)  
page 129

PRODUCT NUMBER	L	W	D	∅	SH	BH	TH	MW	LS	DIM
72161-....-100-2	150cm	100cm						2x18w	E27	○
72160-....	150cm							18w	E27	○

- all measurements exclude glasses -



72162-....-35-3

+  
621....-....-....  
621....-....-....  
621....-....-....

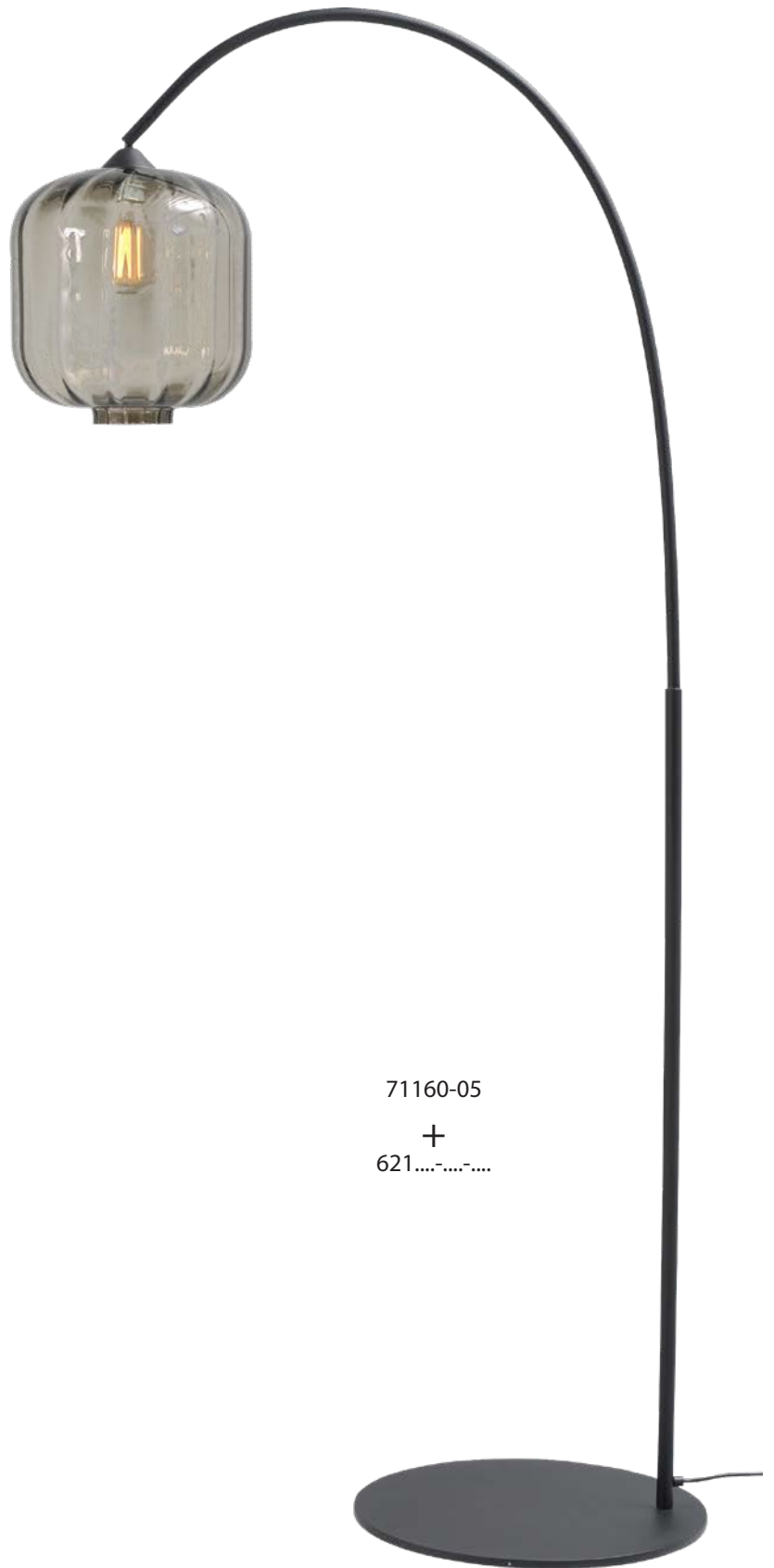

71160-05  
+  
621....-....-....

Glass Number(s)  
page 129

PRODUCT NUMBER	L	W	D	∅	SH	BH	TH	MW	LS	DIM
72162-....-35-3	150cm		35cm					3x18w	E27	○
71160-05			80cm				181cm	18w	E27	⊗

- all measurements exclude glasses -





# LETT

SLF023860409 | RECOMMENDED LED LIGHT BULB



05

Fixture/Frame Color

- Color options available for this collection -



....-05



....-05GL

Shade Color



4165-05-....-20



4166-05-....-28

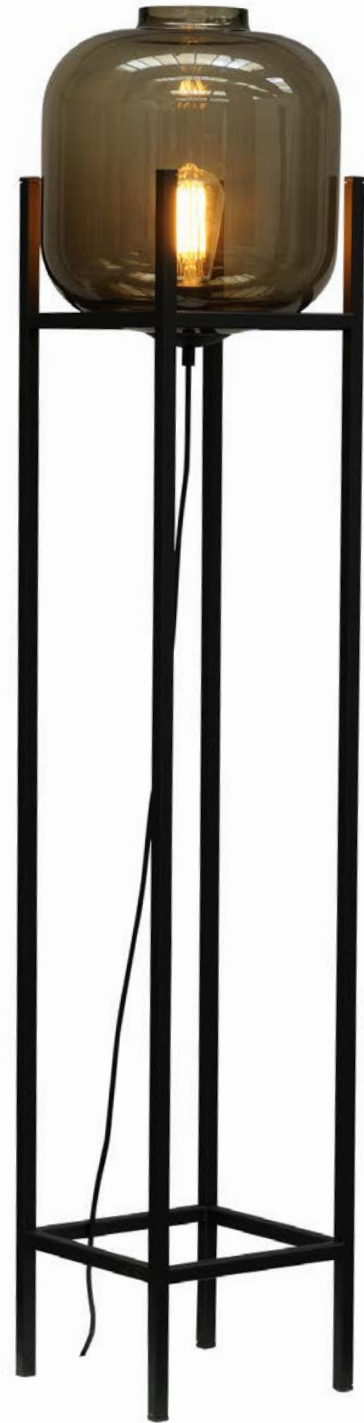

1165-05-....-28

PRODUCT NUMBER	L	W	D	∅	SH	BH	TH	MW	LS	DIM
1165-05-....-28		28cm	28cm	28cm	30cm	112cm	127cm	18w	E27	⊗
4165-05-....-20		20,5cm	20,5cm	20cm	22,5cm	23cm	34cm	18w	E27	⊗
4166-05-....-28		28cm	38cm	28cm	30cm	42cm	57cm	18w	E27	⊗



# OCTO

SY0028009 | RECOMMENDED LED LIGHT BULB



SY0028006 |



05

Fixture/Frame Color

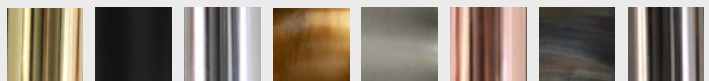

....-02 ....-05 ....-07 ....-10 ....-37 ....-56 ....-66 ....-82

- Color options available for this collection - Socket cover / Shade Color



5350-05-....



5351-05-....



3350-05-....



1351-05-....

PRODUCT NUMBER	L	W	D	∅	SH	BH	TH	MW	LS	DIM
1351-05-....							168cm	18w	E27	○
3350-05-....		25cm	17cm				50cm	3x18w	E27	⊗
5350-05-....		95cm					50cm	6x18w	E27	○
5351-05-....		70cm					65cm	6x18w	E27	○





1350-05-....

2351-05-....

PRODUCT NUMBER	L	W	D	∅	SH	BH	TH	MW	LS	DIM
1350-05-....		30 cm					153 cm	18 w	E27	⊗
2351-05-....	70-140 cm	120 cm	58 cm					8x18 w	E27	○



2350-05-....



1352-05-....



4350-05-....

PRODUCT NUMBER	L	W	D	∅	SH	BH	TH	MW	LS	DIM
1352-05-....							32,5 cm	5x18w	E27	⊗
2350-05-....	70-140cm	97cm	41cm			47cm		6x18w	E27	○
4350-05-....			15cm				52cm	18w	E27	⊗

# OGIVA

SY0029003 | RECOMMENDED LED LIGHT BULB



SY0026683 |



37

Fixture/Frame Color

- Color options available for this collection -



00-00



05-05



06-06

Shade Color



2050-....-ST



2050-....-ST



2050-....-ST

PRODUCT NUMBER	L	W	D	∅	SH	BH	TH	MW	LS	DIM
2050-....-ST	150cm			54cm	40cm			18w	E27	○

# PINEAPPLE

SLF023860409 | RECOMMENDED LED LIGHT BULB



05

Fixture/Frame Color

- Color options available for this collection -



.....-05 .....-00

Shade Color





2291-05-....-130-4

PRODUCT NUMBER	L	W	D	∅	SH	BH	TH	MW	LS	DIM
2291-05-....-130-4	150cm	130cm		18cm	23cm			4x18w	E27	○



2291-05-....-100-3

2290-05-....

PRODUCT NUMBER	L	W	D	∅	SH	BH	TH	MW	LS	DIM
2290-05-....	150cm			18cm	23cm			18w	E27	○
2291-05-....-100-3	150cm	100cm		18cm	23cm			3x18w	E27	○



2292-05-....-35-3



2292-05-....-50-6

PRODUCT NUMBER	L	W	D	∅	SH	BH	TH	MW	LS	DIM
2292-05-....-35-3	150cm	35cm		18cm	23cm			3x18w	E27	○
2292-05-....-50-6	400cm	50cm		18cm	23cm			6x18w	E27	○

# QUINTO

SY0028002 | RECOMMENDED LED LIGHT BULB



05

Fixture/Frame Color

- Color options available for this collection -

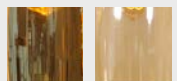

....-05 ....-14  
Shade Color

# SMOKE GLASS



62260-05-1



62260-05-2



62260-05-3



62260-05-4



62260-05-5



62260-05-6



62260-05-7



62260-05-8



62260-05-9



62260-05-10



62260-05-11



62260-05-12



62260-05-13

PRODUCT NUMBER	L	W	D	∅	SH	BH	TH	LS	DIM
----------------	---	---	---	---	----	----	----	----	-----

62260-05-1				17cm	18,5cm			E27	
62260-05-2				21cm	29cm			E27	
62260-05-3				20cm	19,5cm			E27	
62260-05-4				20cm	18,5cm			E27	
62260-05-5				13cm	29cm			E27	
62260-05-6				20cm	18cm			E27	
62260-05-7				14,5cm	15,5cm			E27	
62260-05-8				23cm	20cm			E27	
62260-05-9				20cm	11,5cm			E27	
62260-05-10				14,5cm	25,5cm			E27	
62260-05-11				11,5cm	20cm			E27	
62260-05-12				22,5cm	21cm			E27	
62260-05-13				25,5cm	20,5cm			E27	





72261-05-100-3

+  
62260-....-....  
62260-....-....  
62260-....-....



72261-05-130-5

+  
62260-....-....  
62260-....-....  
62260-....-....  
62260-....-....  
62260-....-....

PRODUCT NUMBER	L	W	D	∅	SH	BH	TH	MW	LS	DIM
72261-05-100-3	150cm	100cm						3x18w	E27	○
72261-05-130-5	150cm	130cm						5x18w	E27	○

- all measurements exclude glasses -



72262-05-50-5  
 +  
 62260-....-....  
 62260-....-....  
 62260-....-....  
 62260-....-....  
 62260-....-....



72260-05  
 +  
 62260-....-....



71261-05-130  
 +  
 62260-....-....



71261-05-155  
 +  
 62260-....-....

Glass Number(s)  
 Smoke page 151  
 Amber page 154

PRODUCT NUMBER	L	W	D	∅	SH	BH	TH	MW	LS	DIM
72260-05	150cm	10cm						18w	E27	○
71261-05-130							130cm	18w	E27	⊗
71261-05-155							155cm	18w	E27	⊗
72262-05-50-5	150cm	50cm						5x18w	E27	○

- all measurements exclude glasses -

# AMBER GLASS



62260-14-1



62260-14-2



62260-14-3



62260-14-4



62260-14-5



62260-14-6



62260-14-7



62260-14-8



62260-14-9



62260-14-10



62260-14-11



62260-14-12



62260-14-13

PRODUCT NUMBER	L	W	D	∅	SH	BH	TH	LS	DIM
62260-14-1				17cm	18,5cm			E27	
62260-14-2				21cm	29cm			E27	
62260-14-3				20cm	19,5cm			E27	
62260-14-4				20cm	18,5cm			E27	
62260-14-5				13cm	29cm			E27	
62260-14-6				20cm	18cm			E27	
62260-14-7				14,5cm	15,5cm			E27	
62260-14-8				23cm	20cm			E27	
62260-14-9				20cm	11,5cm			E27	
62260-14-10				14,5cm	25,5cm			E27	
62260-14-11				11,5cm	20cm			E27	
62260-14-12				22,5cm	21cm			E27	
62260-14-13				25,5cm	20,5cm			E27	







72261-05-130-25-8

+

62260-....-.... 62260-....-....  
 62260-....-.... 62260-....-....  
 62260-....-.... 62260-....-....  
 62260-....-....



74260-05

+

62260-....-....

PRODUCT NUMBER	L	W	D	∅	SH	BH	TH	MW	LS	DIM
74260-05		11cm				5cm		18w	E27	⊗
72261-05-100-25-8	150cm	130cm	25cm					8x18w	E27	○

- all measurements exclude glasses -





72262-05-35-3

+  
62260-....-....  
62260-....-....  
62260-....-....



75260-05

+  
62260-....-....



71260-05

+  
62260-....-....



74261-05

+  
62260-....-....

Glass Number(s)  
Smoke page 151  
Amber page 154

PRODUCT NUMBER	L	W	D	Ø	SH	BH	TH	MW	LS	DIM
71260-05							161cm	18w	E27	⊗
75260-05		10cm						18w	E27	○
72262-05-35-3	250cm	35cm						3x18w	E27	○
74261-05							71cm	18w	E27	⊗

- all measurements exclude glasses -

SY0028002 | RECOMMENDED LED LIGHT BULB





# R U N

SY0029962 | RECOMMENDED LED LIGHT BULB



05

Fixture/Frame Color



....-00



....-05



....-06



....-10



....-30



....-37



....-66



....-75

- Color options available for this collection -

Shade Color



2381-05-....-130-25-8

PRODUCT NUMBER	L	W	D	∅	SH	BH	TH	MW	LS	DIM
2381-05-....-130-25-8	150cm	130cm	25cm	5,5cm	30cm			8x18w	GU10	○





2382-05-....-35-3



2381-05-....-100-4

PRODUCT NUMBER	L	W	D	∅	SH	BH	TH	MW	LS	DIM
2381-05-....-100-4	150cm	100cm		5,5cm	30cm			4x18w	GU10	○
2382-05-....-35-3	250cm	35cm		5,5cm	30cm			3x18w	GU10	○



2381-05-....-130-5

2380-05-....

PRODUCT NUMBER	L	W	D	∅	SH	BH	TH	MW	LS	DIM
2380-05-....	150cm			5,5cm	30cm			18w	GU10	○
2381-05-....-130-5	150cm	130cm		5,5cm	30cm			5x18w	GU10	○

# TESSI

SLF023981405 | SLF023981305 | SLF023981205 | SLF023981105 | RECOMMENDED LED LIGHT BULB



05

Fixture/Frame Color



....00 ....02 ....05 ....06 ....07 ....10 ....37 ....56 ....66 ....82

- Color options available for this collection - Socket cover / Shade Color



SLF023981105



SLF023981205



SLF023981305



SLF023981405

PRODUCT NUMBER	L	W	D	∅	SH	BH	TH	LW	LM	K	LS	DIM
LF023981105				16.5 cm	30 cm			4 w	250	2000k		○
LF023981205				20 cm	29 cm			4 w	250	2000k		○
LF023981305				18 cm	37 cm			4 w	250	2000k		○
LF023981405				12 cm	44 cm			4 w	250	2000k		○



1461-05-....-155



1461-05-....-130



2237-....-100-3

PRODUCT NUMBER	L	W	D	∅	SH	BH	TH	MW	LS	DIM
1461-05-....-130						130cm		18w	E27	⊗
1461-05-....-155						155cm		18w	E27	⊗
2237-....-100-3	150cm	100cm						3x18w	E27	○





2237-....-130-25-8



4237-....

PRODUCT NUMBER	L	W	D	∅	SH	BH	TH	MW	LS	DIM
2237-....-130-25-8	150cm	130cm	25cm					8x18w	E27	○
4237-....		11cm				12cm		18w	E27	⊗



2237-....



2238-....-35-3



2238-....-50-5

PRODUCT NUMBER	L	W	D	∅	SH	BH	TH	MW	LS	DIM
2237-....	150cm	11cm						18w	E27	○
2238-....-35-3	150cm	35cm						3x18w	E27	○
2238-....-50-5	150cm	50cm						5x18w	E27	○



2237-....-130-4



4237-....

PRODUCT NUMBER	L	W	D	∅	SH	BH	TH	MW	LS	DIM
2237-....-130-4	150cm	130cm						4x18w	E27	○
4237-....		11cm				12cm		18w	E27	⊗

# TRIP

SY0026683 | RECOMMENDED LED LIGHT BULB



00-.... 05-.... 06-....  
Fixture/Frame Color

- Color options available for this collection -

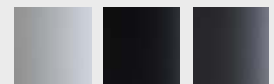

....-11 ....-20 ....-83  
Shade Color



....-06-....-11-....



....-06-....-11-....



....-05-....-20-....



....-05-....-20-....



....-00-....-83-....



....-00-....-83-....



1176-....-6390-....-50



1176-....-6411-....-55

PRODUCT NUMBER	L	W	D	∅	SH	BH	TH	MW	LS	DIM
1176-....-6390-....-50				50cm	48cm		183cm	18w	E27	⊗
1176-....-6411-....-55				55cm	55cm		190cm	18w	E27	⊗



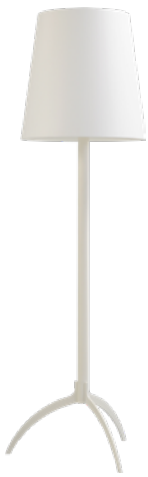

....-06-....-11-....



....-06-....-11-....



....-05-....-20-....



....-05-....-20-....



....-00-....-83-....



....-00-....-83-....



1179-....-6390-....-50



1179-....-6411-....-55

PRODUCT NUMBER	L	W	D	∅	SH	BH	TH	MW	LS	DIM
1179-....-6390-....-50				50cm	48cm		183cm	18W	E27	⊗
1179-....-6411-....-55				55cm	55cm		195cm	18W	E27	⊗



....-06-....-11-....



....-06-....-11-....



....-05-....-20-....



....-05-....-20-....



....-00-....-83-....



....-00-....-83-....



1175-....-6390-....-50



1175-....-6411-....-55

PRODUCT NUMBER	L	W	D	∅	SH	BH	TH	MW	LS	DIM
1175-....-6390-....-50				50cm	48cm		183cm	18w	E27	⊗
1175-....-6411-....-55				55cm	55cm		190cm	18w	E27	⊗



PRODUCT NUMBER	L	W	D	∅	SH	BH	TH	MW	LS	DIM
1177-....-6390-....-60				60 cm	38 cm		178 cm	18 W	E27	⊗
1177-....-6411-....-55				55 cm	55 cm		190 cm	18 W	E27	⊗



....-06-....-11-....



....-06-....-11-....



....-05-....-20-....



....-05-....-20-....



....-00-....-83-....



....-00-....-83-....



1178-....-6390-....-60



1178-....-6411-....-55

PRODUCT NUMBER	L	W	D	∅	SH	BH	TH	MW	LS	DIM
1178-....-6390-....-60				60cm	38cm		177cm	18W	E27	⊗
1178-....-6411-....-55				55cm	55cm		194cm	18W	E27	⊗

CUSTOM MADE - ON REQUEST



Velvet shade color options - inside shade gold



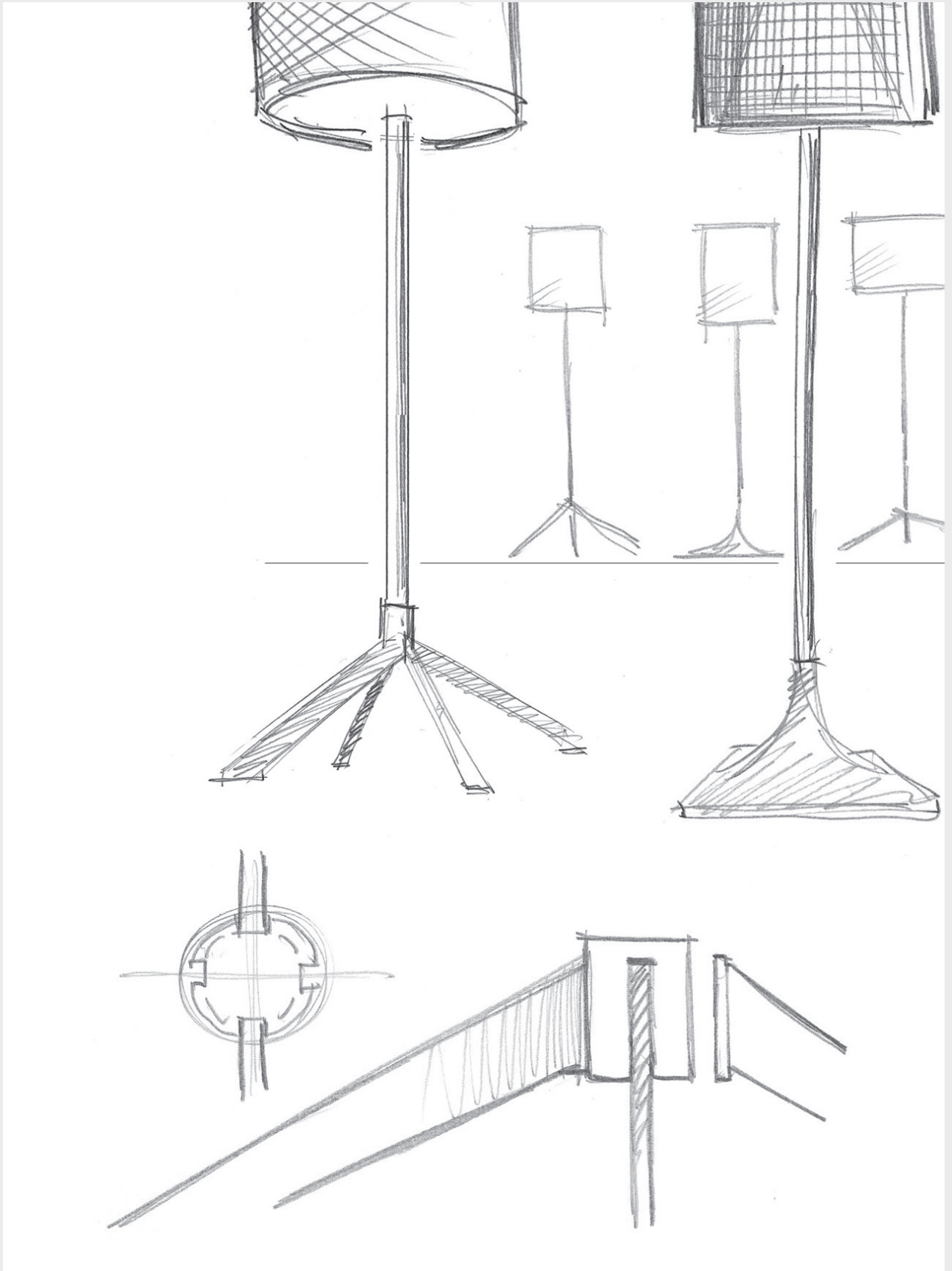

# TUBE

SY0028009 | RECOMMENDED LED LIGHT BULB



SY0028006 |



05

Fixture/Frame Color

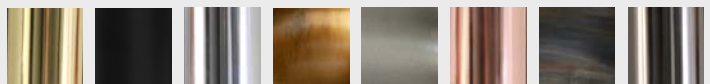

....-02 ....-05 ....-07 ....-10 ....-37 ....-56 ....-66 ....-82

- Color options available for this collection - Socket cover / Shade Color



1461-05-....-130

1461-05-....-155

1460-05-....

4460-05-....

PRODUCT NUMBER	L	W	D	∅	SH	BH	TH	MW	LS	DIM
1460-05-....			23cm				134cm	18w	E27	⊗
1461-05-....-130			15cm				136cm	18w	E27	⊗
1461-05-....-155			15cm				161cm	18w	E27	⊗
4460-05-....			17cm				48cm	18w	E27	⊗



5461-05-....



2461-05-....

PRODUCT NUMBER	L	W	D	∅	SH	BH	TH	MW	LS	DIM
2461-05-....	70-140cm	130cm	34cm			12cm		12x18w	E27	○
5461-05-....			45cm			40cm		5x18w	E27	○



5460-05-....



2460-05-....

PRODUCT NUMBER	L	W	D	∅	SH	BH	TH	MW	LS	DIM
2460-05-....	70-140cm	100cm	34cm			12cm		10x18w	E27	○
5460-05-....			45cm			42cm		3x18w	E27	○



# VENUS

SY0026683 | RECOMMENDED LED LIGHT BULB



05

Fixture/Frame Color

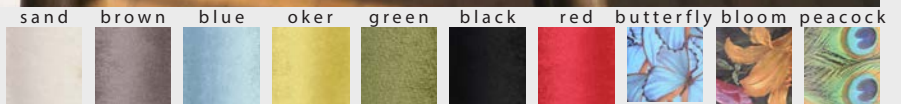

-12

-15

-13

-11

-04

-05

-03

-VL

-BL

-PA

- Color options available for this collection -

Shade Color



-15



-12



-03



-05



-13



-VL



-11



-BL



-04



-PA



1470-05-....-155



1470-05-....-130



4470-05-....-30

PRODUCT NUMBER	L	W	D	∅	SH	BH	TH	MW	LS	DIM
1470-05-....-155				20cm	15cm		175cm	18w	E27	⊗
1470-05-....-130				20cm	15cm		150cm	18w	E27	⊗
4470-05-....-30				20cm	15cm		55cm	18w	E27	⊗

# ZYAN

LED 5 YEARS WARRANTY

Dim to Warm



05

Fixture/Frame Color

- Color options available for this collection -

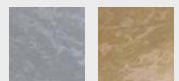

.....-37

.....-08

Shade Color

CUSTOM MADE - ON REQUEST



5205-....-150-90-60-DW

PRODUCT NUMBER	L	W	D	∅	SH	BH	TH	LW	LM	K	LS	DIM	
				150 cm			184 cm						
5205-....-150-90-60-DW				90 cm				19 w	1800	2200/2700 K		○	
				60 cm				9 w	900	2200/2700 K			
				15 cm				9 w	900	2200/2700 K			



5200-....-90-DW



5200-....-60-DW



3200-....-30-DW

PRODUCT NUMBER	L	W	D	∅	SH	BH	TH	LW	LM	K	LS	DIM	
3200-....-30-DW			14 cm	30 cm				7 w	700	2200/2700k		<input type="radio"/>	
5200-....-90-DW				90 cm			50 cm	9 w	900	2200/2700k		<input type="radio"/>	
5200-....-60-DW				60 cm			50 cm	9 w	900	2200/2700k		<input type="radio"/>	





5205-....-90-60-DW



3200-....-30-DW

PRODUCT NUMBER	L	W	D	∅	SH	BH	TH	LW	LM	K	LS	DIM	
3200-....-30-DW			14 cm	30 cm				7 w	700	2200/2700K		○	
5205-....-90-60-DW				90 cm	+60 cm		84 cm	2x9 w	2x900	2200/2700K		○	

H O M E

C O L L E C T I O N

**master**light



# HOME



Al Tonno  
192/193

---



Baldi  
194/197

---



Baloton  
198/205

---



Big 'Denia'  
206/207

---



Bocca  
208/211

---



Bolzano  
212/215

---



Bones  
216/217

---



Bounce  
218/221

---



Bubble  
222/225

---



Calabro  
226/229

---



Catarina  
230/235

---



Cilindra  
236/239

---



Corona  
240/241

---



Curlie  
242/243

---



Dante  
244/247

---



Denia I  
248/253

---



Denia II  
254/257

---



Di Moda  
258/261

---



Donna  
262/263

---

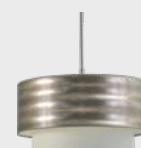

Dopler  
264/271

---



Flute  
272/277

---



Gio  
278/281

---



Iota  
282/283

---



Melani  
284/289

---

# INDEX



Metallico  
290/295

---



Mika  
296/297

---



Milan  
298/303

---



Modern Crown  
304/305

---



Molto II  
306/309

---



Molto III  
310/315

---



Moskow  
316/319

---



O.A.K. 'Real Wood'  
320/323

---



Oblica  
324/325

---



Ovum 'Vigo II'  
326/327

---



Plafonniere  
328/333

---



Real II  
334/337

---



Real III  
338/341

---



Roma  
342/345

---



Solta  
346/349

---



Terra  
350/351

---



Tondo  
352/353

---



Torcello  
354/357

---



Verona  
358/361

---



Vesto  
362/365

---



Vigo  
366/371

---



# AL TONNO

SY0026683 | RECOMMENDED LED LIGHT BULB

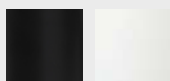

05-.... 06-....  
Fixture/Frame Color

- Color options available for this collection -



....-11 ....-20  
Shade Color



1165-06-6390-11-50



1165-05-6390-20-50

PRODUCT NUMBER	L	W	D	∅	SH	BH	TH	MW	LS	DIM
1165-.....-6390-.....-50				50cm	48cm	127cm	175cm	18w	E27	⊗

# BALDI

SY0028006 | RECOMMENDED LED LIGHT BULB



37

Fixture/Frame Color

- Color options available for this collection -



00

Shade Color



2530-37-00



2532-37-00-50-3

PRODUCT NUMBER	L	W	D	∅	SH	BH	TH	MW	LS	DIM
2530-37-00	150cm			25,5cm	24cm			18w	E27	○
2532-37-00-50-3	150cm	50cm		25,5cm	24cm			3x18w	E27	○



2531-37-00-160-4



4530-37-00

PRODUCT NUMBER	L	W	D	∅	SH	BH	TH	MW	LS	DIM
2531-37-00-160-4	150cm			25,5cm	24cm			4x18w	E27	○
4530-37-00				25,5cm	24cm	21cm	45cm	18w	E27	⊗





2531-37-00-130-3

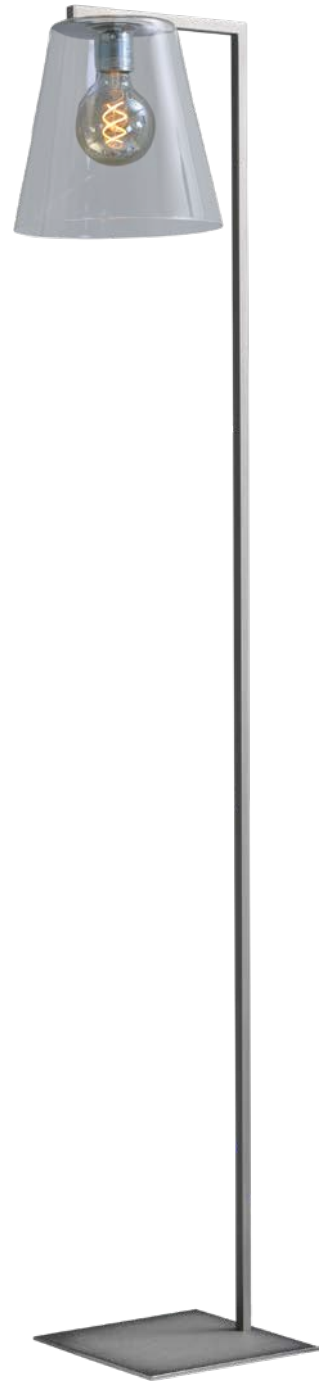

1530-37-00

PRODUCT NUMBER	L	W	D	∅	SH	BH	TH	MW	LS	DIM
1530-37-00			25,5cm	24cm			161cm	18w	E27	⊗
2531-37-130-3	150cm		25,5cm	24cm	48cm			3x18w	E27	○

# BALOTON

SLF023860609 | RECOMMENDED LED LIGHT BULB

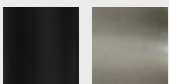

....-05 ....-37

Fixture/Frame Color

- Color options available for this collection -

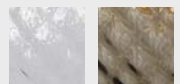

....-00 ....-05

Shade Color



61340-05-20



61340-05-25



61340-05-30



61340-00-20



61340-00-25



61340-00-30

PRODUCT NUMBER	L	W	D	∅	SH	BH	TH	LS	DIM
61340-05-20				19,5cm	18cm			E27	
61340-05-25				25cm	23,5cm			E27	
61340-05-30				30cm	28,5cm			E27	
61340-00-20				19,5cm	18cm			E27	
61340-00-25				25cm	23,5cm			E27	
61340-00-30				30cm	28,5cm			E27	



72341-....-130-4

+

61340-....-....

61340-....-....

61340-....-....

61340-....-....

PRODUCT NUMBER	L	W	D	Ø	SH	BH	TH	MW	LS	DIM
72341-....-130-4	150cm	130cm						4x18w	E27	○

- all measurements exclude glasses -



72342-....-35-3

+  
61340-....-....  
61340-....-....  
61340-....-....

Glass Number(s)  
page 199



72342-....-50-6

+  
61340-....-....  
61340-....-....  
61340-....-....  
61340-....-....  
61340-....-....  
61340-....-....

PRODUCT NUMBER	L	W	D	∅	SH	BH	TH	MW	LS	DIM
72342-....-35-3	150cm	35cm						3x18w	E27	○
72342-....-50-6	150cm	50cm						6x18w	E27	○

- all measurements exclude glasses -





1340-05-....-30



4340-05-....-30



72340-....  
+  
61340-....-....



112cm 127cm  
42cm 57cm

PRODUCT NUMBER	L	W	D	∅	SH	BH	TH	LS	DIM	
1340-05-....-30		28cm	28cm	30cm	28,5cm	112cm	127cm	18w	E27	⊗
4340-05-....-30		28cm	28cm	30cm	28,5cm	42cm	57cm	18w	E27	⊗
72340-....	150cm							18w	E27	○

- all measurements exclude glasses -



72341-....-160-25-8

+

61340-....-.... 61340-....-....  
 61340-....-.... 61340-....-....  
 61340-....-.... 61340-....-....  
 61340-....-.... 61340-....-....

Glass Number(s)  
 page 199

PRODUCT NUMBER	L	W	D	∅	SH	BH	TH	MW	LS	DIM
72341-....-160-25-8	150cm	160cm	25cm					8x18w	E27	○

- all measurements exclude glasses -







# BIG

| Denia BIG |

Dim to Warm | LED 5 YEAR WARRANTY

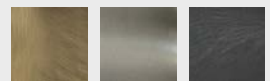

....-01 ....-37 ....-81

- Color options available for this collection - Fixture/Frame/Shade Color





1361-....-10-DW

1180-....-10-DW

1184-....-10-DW

1182-....10-DW

PRODUCT NUMBER	L	W	D	∅	SH	BH	TH	LW	LM	K	LS	DIM	
1180-....-10-DW				10cm	1,5cm		130cm	8w	960	2200/2700K		●	
1182-....-10-DW				10cm	1,5cm		130cm	8w	960	2200/2700K		●	
1184-....-10-DW				10cm	1,5cm		150cm	8w	960	2200/2700K		●	
1361-....-10-DW				33cm 10cm	1,5cm 1,5cm		185cm	23w 8w	2760 960	2200/2700K		●	

# BOCCA

Dim to Warm | LED 5 YEAR WARRANTY

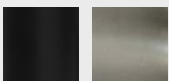

05-.... 37-....

Fixture/Frame Color

- Color options available for this collection -

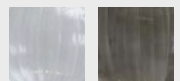

....-00 ....-05

Shade Color



5143-.....-35-3-DW



5140-.....-DW

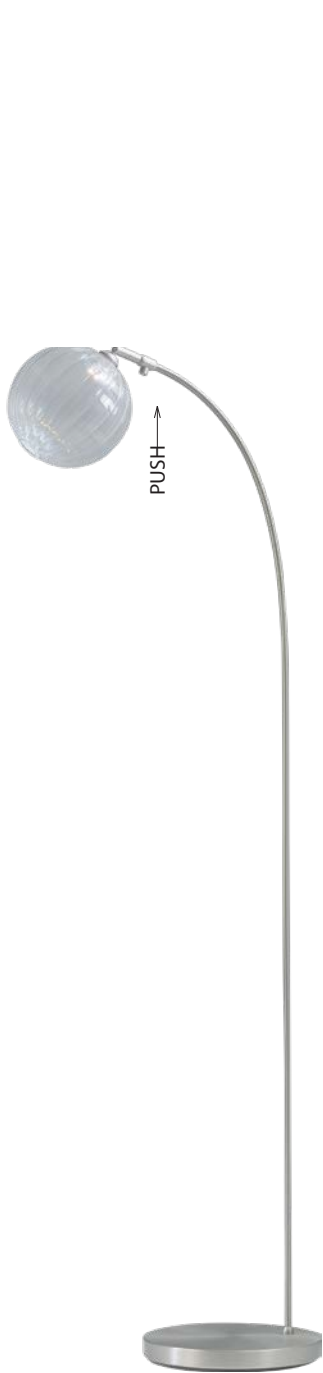

1140-.....-DW

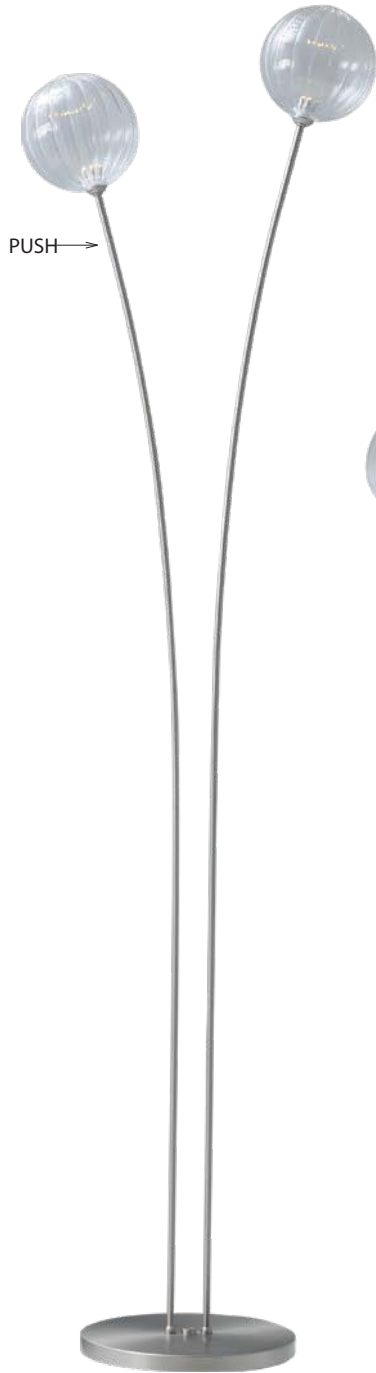

1141-.....-DW



1143-.....-DW

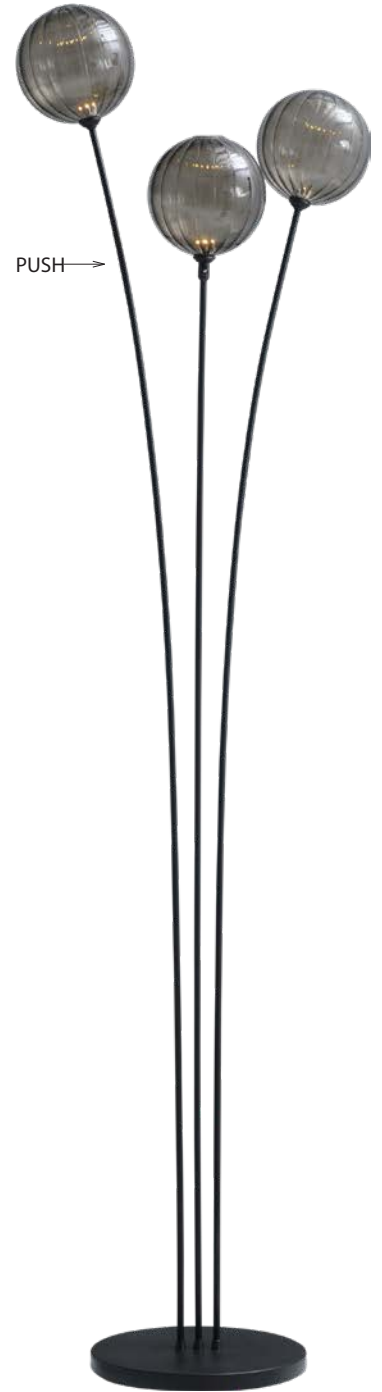

1142-.....-DW

PRODUCT NUMBER	L	W	D	∅	SH	BH	TH	LW	LM	K	LS	DIM	
1140-.....-DW			35 cm	16 cm	15,5 cm		130 cm	4 w	1x450	2200/2700K		●	
1141-.....-DW			50 cm	16 cm	15,5 cm		180 cm	2x4 w	2x450	2200/2700K		●	
1142-.....-DW			50 cm	16 cm	15,5 cm		180 cm	3x4 w	3x450	2200/2700K		●	
1143-.....-DW			58 cm	16 cm	15,5 cm		180 cm	3x4 w	3x450	2200/2700K		●	
5140-.....-DW		11 cm		16 cm	15,5 cm		18 cm	4 w	450	2200/2700K		○	
5143-.....-35-3-DW		35 cm		16 cm	15,5 cm		18 cm	3x4 w	3x450	2200/2700K		○	



2142-....-50-5-DW



2141-....-100-3-DW

2140-....-DW



4141-....-DW

PRODUCT NUMBER	L	W	D	∅	SH	BH	TH	LW	LM	K	LS	DIM	
2140-....-....-DW	150cm	10cm		16cm	15,5cm			4w	450	2200/2700K		<input type="radio"/>	
2141-....-....-100-3-DW	150cm	100cm		16cm	15,5cm			3x4w	3x450	2200/2700K		<input type="radio"/>	
2142-....-....-50-5-DW	350cm	50cm		16cm	15,5cm			5x4w	5x450	2200/2700K		<input type="radio"/>	
4141-....-....-DW				16cm	15,5cm		40cm	4w	450	2200/2700K		<input checked="" type="radio"/>	



2141-.....-130-4-DW



2142-.....-35-3-DW



3140-.....-DW

PRODUCT NUMBER	L	W	D	∅	SH	BH	TH	LW	LM	K	LS	DIM	
2141-.....-130-4-DW	150cm	130cm		16cm	15,5cm			4x4w	4x450	2200/2700k		<input type="radio"/>	
2142-.....-35-3-DW	150cm	35cm		16cm	15,5cm			3x4w	3x450	2200/2700k		<input type="radio"/>	
3140-.....-DW				16cm	15,5cm	11cm	21cm	4w	450	2200/2700k		<input checked="" type="radio"/>	



# BOLZANO

SY0026648 | SY0026947 | RECOMMENDED LED LIGHT BULB



21

Fixture/Frame Color

- Color options available for this collection -



34

Shade Color



1935-21-34



1936-21-34

PRODUCT NUMBER	L	W	D	∅	SH	BH	TH	MW	LS	DIM
1935-21-34				40 cm	13,5 cm		182 cm	18 W	E27	●
1936-21-34		49 cm		40 cm	13,5 cm		182 cm	18 W	E27	●
				17 cm	10 cm			18 W	E27	⊗



2938-21-34



2939-21-34



2936-21-34



4936-21-34

PRODUCT NUMBER	L	W	D	∅	SH	BH	TH	MW	LS	DIM
2936-21-34	80-135 cm	89 cm		30 cm	10,5 cm			2x18w	E27	○
2938-21-34	90 cm	63 cm		17 cm	10 cm			5x18w	E27	○
2939-21-34	80-135 cm	134 cm		30 cm	10,5 cm			4x18w	E27	○
4936-21-34		30 cm		30 cm	10,5 cm		48 cm	1x18w	E27	⊗



5935-21-34



5936-21-34



2937-21-34



2935-21-34



3935-21-34



3936-21-34

PRODUCT NUMBER	L	W	D	∅	SH	BH	TH	MW	LS	DIM
2935-21-34	80-115 cm		40 cm	40 cm	13,5 cm			1x18 w	E27	○
3935-21-34		17 cm	27 cm	17 cm	10 cm		25 cm	1x18 w	E27	⊗
3936-21-34		30 cm	15 cm	1/230 cm	10,5 cm		17,5 cm	1x18 w	E27	⊗
2937-21-34	80-135 cm	107 cm	30 cm	30 cm	10,5 cm			3x18 w	E27	○
5935-21-34				30 cm	10,5 cm		11,5 cm	1x18 w	E27	○
5936-21-34				40 cm	13,5 cm		14,5 cm	2x18 w	E27	○

# BONES

SY0029962 | RECOMMENDED LED LIGHT BULB



05

Fixture/Frame Color

- Color options available for this collection -



....-05



....-10

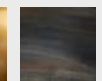

....-66

Shade Color



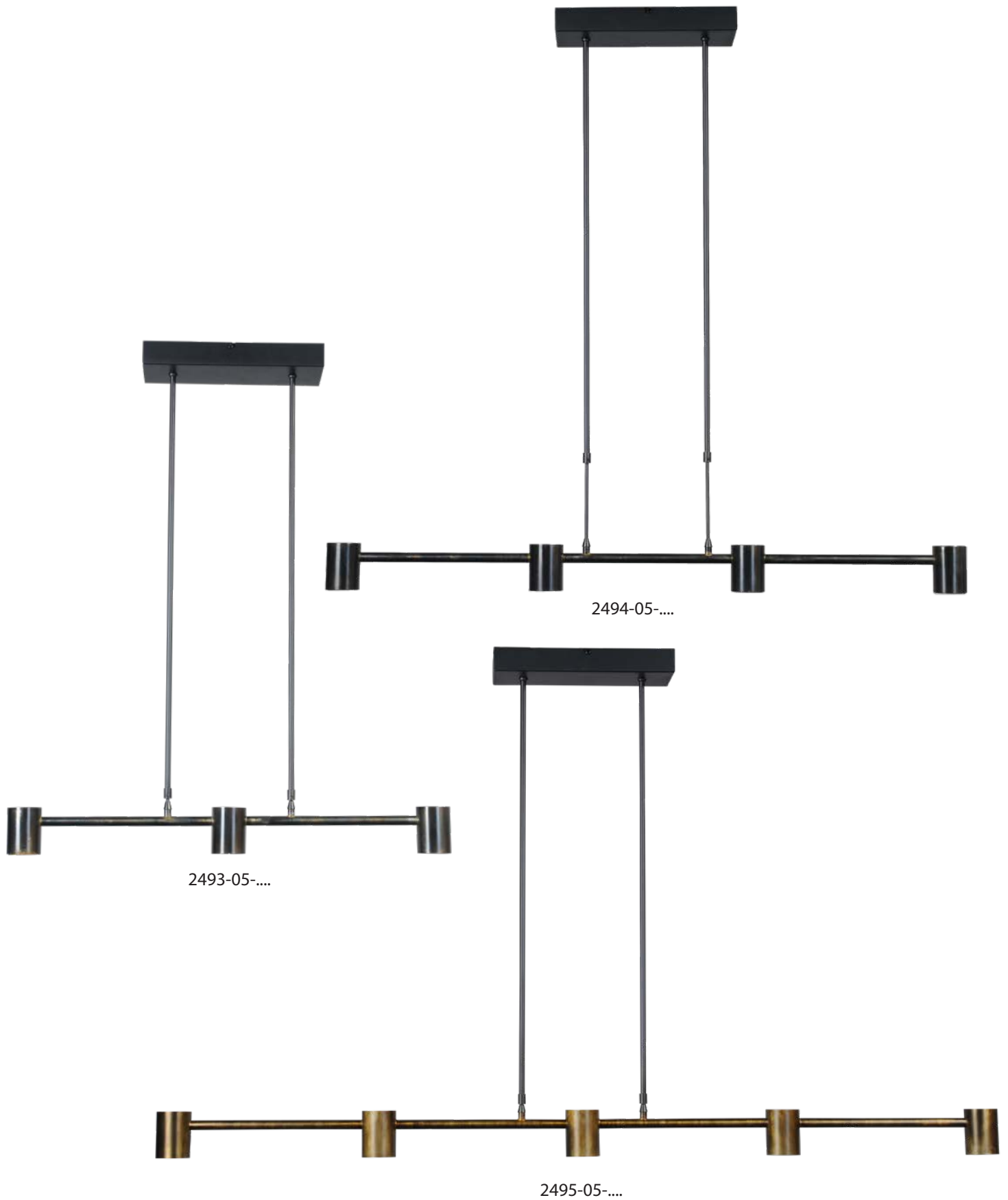

2493-05-....

2494-05-....

2495-05-....

PRODUCT NUMBER	L	W	D	∅	SH	BH	TH	MW	LS	DIM
2493-05-....	80-115 cm	71 cm		5,5 cm	7,5 cm			3x18w	Gu10	○
2494-05-....	80-115 cm	105 cm		5,5 cm	7,5 cm			4x18w	Gu10	○
2495-05-....	80-115 cm	138 cm		5,5 cm	7,5 cm			5x18w	Gu10	○

# BOUNCE

SY0029962 | RECOMMENDED LED LIGHT BULB



05

Fixture/Frame Color



....-02



....-05

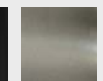

....-37

Shade Color

- Color options available for this collection -



5492-05-05-35-3



5490-05-05



5492-05-02-35-3



5490-05-02

PRODUCT NUMBER	L	W	D	∅	SH	BH	TH	MW	LS	DIM
5490-05-...		11 cm		5,5 cm	7,5 cm	12,5 cm	15 cm	18 W	Gu10	○
5492-05-...-35-3		35 cm		5,5 cm	7,5 cm	12,5 cm	15,5 cm	3x18 W	Gu10	○



5491-05-05-130-5



5491-05-05-100-4



5491-05-05-40-2



5491-05-05-70-3

PRODUCT NUMBER	L	W	D	∅	SH	BH	TH	MW	LS	DIM
5491-05-...-130-5	130cm	8cm	8cm	5,5cm	7,5cm	12,5cm	16cm	5x18W	Gu10	○
5491-05-...-100-4	100cm	8cm	8cm	5,5cm	7,5cm	12,5cm	16cm	4x18W	Gu10	○
5491-05-...-70-3	70cm	9cm	9cm	5,5cm	7,5cm	12,5cm	16cm	3x18W	Gu10	○
5491-05-...-40-2	40cm	11cm	11cm	5,5cm	7,5cm	12,5cm	16cm	2x18W	Gu10	○



5491-05-02-130-5



5491-05-02-100-4



5491-05-02-40-2



5491-05-02-70-3

PRODUCT NUMBER	L	W	D	∅	SH	BH	TH	MW	LS	DIM
5491-05-...-130-5	130cm	8cm	8cm	5,5cm	7,5cm	12,5cm	16cm	5x18W	Gu10	○
5491-05-...-100-4	100cm	8cm	8cm	5,5cm	7,5cm	12,5cm	16cm	4x18W	Gu10	○
5491-05-...-70-3	70cm	9cm	8cm	5,5cm	7,5cm	12,5cm	16cm	3x18W	Gu10	○
5491-05-...-40-2	40cm	11cm	8cm	5,5cm	7,5cm	12,5cm	16cm	2x18W	Gu10	○



# BUBBLE

Dim to Warm | LED 5 YEAR WARRANTY



37

Fixture/Frame Color

- Color options available for this collection -



176

Shade Color



5890-37-176-12-DW



5890-37-176-7-DW



5890-37-176-5-DW

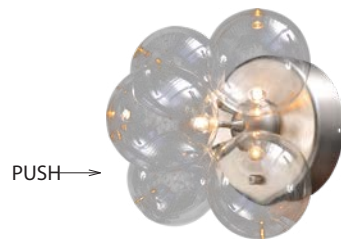

3890-37-176-DW

PRODUCT NUMBER	L	W	D	∅	SH	BH	TH	LW	LM	K	LS	DIM	
3890-37-176-DW			21 cm	10 cm	10,5 cm			5x2w	5x150	2200/2700k		●	
5890-37-176-5-DW			21 cm	10 cm	10,5 cm			5x2w	5x150	2200/2700k		○	
5890-37-176-7-DW			40 cm	10 cm	10,5 cm			7x2w	7x150	2200/2700k		○	
5890-37-176-12-DW			48 cm	10 cm	10,5 cm			12x2w	12x150	2200/2700k		○	



1890-37-176-DW



2891-37-176-130-3-DW



4890-37-176-DW

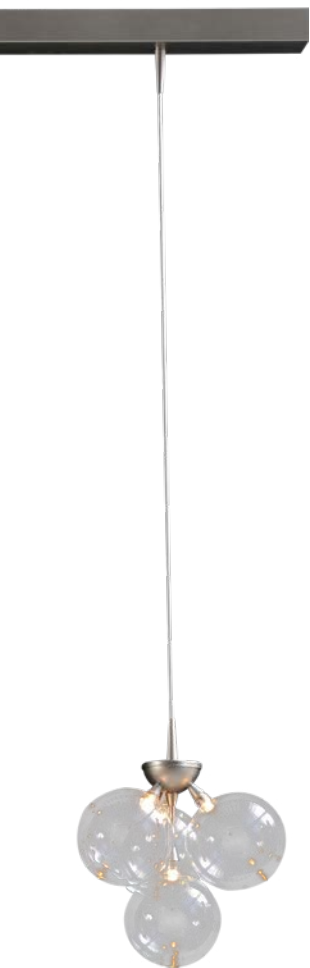

PRODUCT NUMBER	L	W	D	∅	SH	BH	TH	LW	LM	K	LS	DIM	
1890-37-176-DW				10cm	10,5cm		172cm	7x2w	7x150	2200/2700k		●	
2891-37-176-130-3-DW	80-135cm	130cm		10cm	10,5cm			12x2w	12x150	2200/2700k		○	
4890-37-176-DW				10cm	10,5cm		47cm	4x2w	4x150	2200/2700k		●	



2890-37-176-DW



2892-37-176-50-5-DW

PRODUCT NUMBER	L	W	D	∅	SH	BH	TH	LW	LM	K	LS	DIM	
2890-37-176-DW	80-135 cm	21 cm		10 cm	10,5 cm			4x2w	4x150	2200/2700k		<input type="checkbox"/>	
2892-37-176-50-5-DW	80-135 cm	50 cm		10 cm	10,5 cm			20x2w	20x150	2200/2700k		<input type="checkbox"/>	



# CALABRO

SLF022352671 | SY0026648 | SY0026683 | RECOMMENDED LED LIGHT BULB



37

Fixture/Frame Color

- Color options available for this collection -



06

Shade Color





1910-37-06



4911-37-06



4910-37-06

PRODUCT NUMBER	L	W	D	∅	SH	BH	TH	MW	LS	DIM
1910-37-06				41 cm	28 cm		160 cm	18 W	E27	●
4911-37-06				29 cm	35 cm		66 cm	18 W	E27	⊗
4910-37-06				27 cm	23 cm		44 cm	18 W	E27	⊗



2914-37-06-4



3910-37-06

PRODUCT NUMBER	L	W	D	∅	SH	BH	TH	MW	LS	DIM
2914-37-06-4	72-112cm	125cm		14cm	10cm			4x18w	G9	○
3910-37-06			21cm	14cm	10cm	17cm		18w	G9	⊗



PRODUCT NUMBER	L	W	D	∅	SH	BH	TH	MW	LS	DIM
2911-37-06-35-1	91-131 cm			35 cm	29 cm			18 W	E27	○
2913-37-06-3	72-112 cm	90 cm		14 cm	10 cm			3x18 W	G9	○

# CATERINA

Dim to Warm | LED 5 YEAR WARRANTY

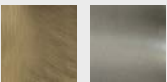

....-01 ....-37

Fixture/Frame Color

- Color options available for this collection -



06

Shade Color



5225-....-06-70-3-DW



5225-....-06-30-2-DW



5226-....-06-35-3-DW



5223-....-06-DW

PRODUCT NUMBER	L	W	D	∅	SH	BH	TH	LW	LM	K	LS	DIM	
5224-....-06-DW		11 cm		12,5 cm	7,5 cm		10 cm	1x4 w	1x450	2200/2700K		<input type="radio"/>	
5225-....-06-30-2-DW		30 cm		12,5 cm	7,5 cm		16 cm	2x4 w	2x450	2200/2700K		<input type="radio"/>	
5225-....-06-70-3-DW		70 cm		12,5 cm	7,5 cm		16 cm	3x4 w	3x450	2200/2700K		<input type="radio"/>	
5226-....-06-35-3-DW		35 cm		12,5 cm	7,5 cm		10,5 cm	3x4 w	3x450	2200/2700K		<input type="radio"/>	



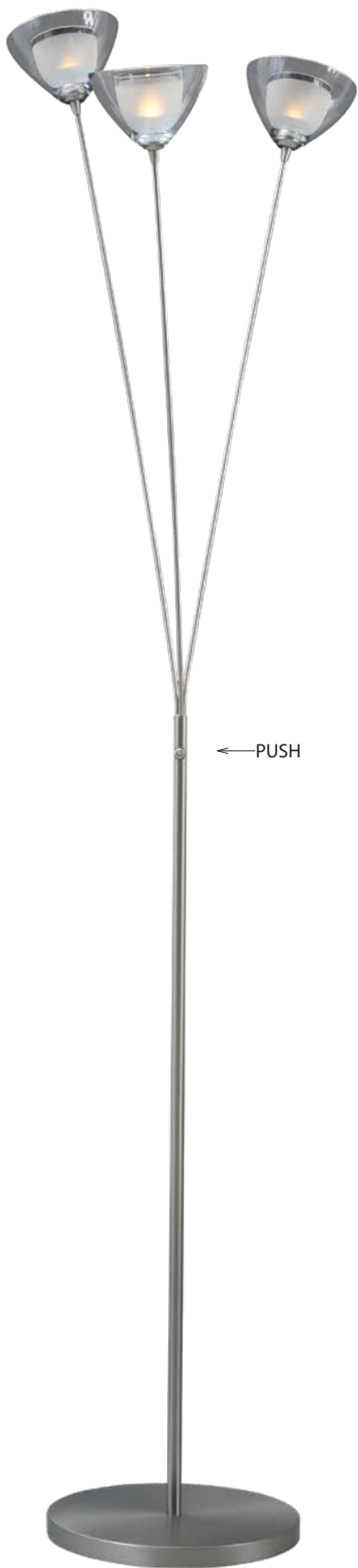

1226-....-06-DW



2225-....-06-100-3-DW

PRODUCT NUMBER	L	W	D	∅	SH	BH	TH	LW	LM	K	LS	DIM	
1226-....-06-DW		35 cm		12,5 cm	7,5 cm		165 cm	3x4 w	3x450	2200/2700K		●	
2225-....-06-100-3-DW	150 cm	100 cm		12,5 cm	7,5 cm			3x4 w	3x450	2200/2700K		○	



2225-....-06-100-4-DW



3225-....-06-DW



3224-....-06-DW

PRODUCT NUMBER	L	W	D	∅	SH	BH	TH	LW	LM	K	LS	DIM	
3224-....-06-DW			15 cm	12,5 cm	7,5 cm		14 cm	1x4 w	450	2200/2700K		●	
3225-....-06-DW			22 cm	12,5 cm	7,5 cm		14 cm	1x4 w	450	2200/2700K		●	
2225-....-06-100-4-DW	150 cm	100 cm		12,5 cm	7,5 cm			4x4 w	4x450	2200/2700K		○	



2225-....-06-130-5-DW

PRODUCT NUMBER	L	W	D	∅	SH	BH	TH	LW	LM	K	LS	DIM	
2225-....-06-130-5-DW	150cm	130cm		12,5cm	7,5cm			5x4w	5x450	2200/2700k		<input type="checkbox"/>	



2226-....-06-35-3-DW



2226-....-06-35-6-DW



4225-....-06-DW



4226-....-06-DW

PRODUCT NUMBER	L	W	D	∅	SH	BH	TH	LW	LM	K	LS	DIM	
2226-....-06-35-6-DW		35 cm		12,5 cm	7,5 cm			6x4 w	3x450	2200/2700K		<input type="radio"/>	
2226-....-06-35-3-DW		35 cm		12,5 cm	7,5 cm			3x4 w	6x450	2200/2700K		<input type="radio"/>	
4225-....-06-DW				12,5 cm	7,5 cm		25 cm	4 w	450	2200/2700K		<input checked="" type="radio"/>	
4226-....-06-DW				12,5 cm	7,5 cm		40 cm	4 w	450	2200/2700K		<input checked="" type="radio"/>	

# CILINDRA

SLF022352671 | SY0026648 | SY0026683 | RECOMMENDED LED LIGHT BULB



37

Fixture/Frame Color

- Color options available for this collection -



06

Shade Color





1110-37-06



4111-37-06



4110-37-06

PRODUCT NUMBER	L	W	D	∅	SH	BH	TH	MW	LS	DIM
1110-37-06			35 cm	35 cm	30 cm		159 cm	18 W	E27	●
4111-37-06			35 cm	29 cm	35 cm		66 cm	18 W	E27	⊗
4110-37-06			25 cm	25 cm	22 cm		54 cm	18 W	E27	⊗



2110-37-06-35



5110-37-06



2114-37-06-3

PRODUCT NUMBER	L	W	D	∅	SH	BH	TH	MW	LS	DIM
2110-37-06-35		35 cm		35 cm	30 cm		159 cm	1x18w	E27	○
2114-37-06-3		93 cm		18 cm	15 cm			3x18w	E27	○
5110-37-06				25 cm	22 cm		28 cm	1x18w	E27	○



5111-37-06

2115-37-06-4



3110-37-06

PRODUCT NUMBER	L	W	D	∅	SH	BH	TH	MW	LS	DIM
2115-37-06-4	72-112cm	128cm		18cm	15cm			4x18W	E27	○
3110-37-06			24cm	18cm	15cm			18W	E27	⊗
5111-37-06				35cm	30cm		34cm	1x18W	E27	○

# CORONA

SLF023850309 | RECOMMENDED LED LIGHT BULB



21

- Color options available for this collection - Fixture/Frame/Shade Color



2534-21



5534-21



3535-21



3536-21



2536-21

PRODUCT NUMBER	L	W	D	∅	SH	BH	TH	MW	LS	DIM
2534-21	90 cm			65 cm		60 cm		6x18w	E14	○
2536-21	90 cm			100 cm		90 cm		9x18w	E14	○
3535-21			26 cm			32 cm		18w	E14	⊗
3536-21			26 cm			30 cm		2x18w	E14	⊗
5534-21				60 cm			66 cm	6x18w	E14	○



# CURLIE

SY0028006 | RECOMMENDED LED LIGHT BULB



2766-35



35

- Color options available for this collection - Fixture/Frame/Shade Color



5766-35



2765-35



3765-35



4765-35



1765-35

PRODUCT NUMBER	L	W	D	∅	SH	BH	TH	MW	LS	DIM
1765-35			45 cm				165 cm	3x18w	E27	⊗
2765-35	70-140 cm	103 cm	65 cm			31 cm		6x18w	E27	○
2766-35	70-140 cm	130 cm	65 cm			31 cm		8x18w	E27	○
3765-35			28 cm				40 cm	18w	E27	⊗
4765-35			35 cm				40 cm	2x18w	E27	⊗
5766-35		103 cm	65 cm			34 cm		6x18w	E27	○

# DANTE

Dim to Warm | LED 5 YEAR WARRANTY



05

- Color options available for this collection - Fixture/Frame/Shade Color



2061-05-DW



2062-05-DW

PRODUCT NUMBER	L	W	D	∅	SH	BH	TH	LW	LM	K	LS	DIM	
2061-05-DW	96-160cm	110cm	42cm			19cm		8x2w	8x150	2200/2700K		●	
2062-05-DW	96-160cm	150cm	50cm			19cm		12x2w	12x150	2200/2700K		●	







# DENIA I

| Denia Square |

Dim to Warm | LED 5 YEAR WARRANTY

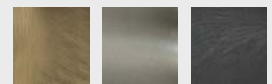

....-01 ....-37 ....-81

- Color options available for this collection - Fixture/Frame/Shade Color



4880-....-DW

1880-....-DW

1881-....-DW

PRODUCT NUMBER	L	W	D	∅	SH	BH	TH	LW	LM	K	LS	DIM	
1881-....-DW		22 cm	68 cm	20-20 cm 5-7 cm	2,5 cm 1,5 cm		185 cm	24 w 6 w	2880 720	2200/2700 K		●	
1880-....-DW		25 cm	68 cm	5-7 cm	1,5 cm		150 cm	6 w	720	2200/2700 K		●	
4880-....-DW		16 cm	20 cm	5-7 cm	1,5 cm		57 cm	6 w	720	2200/2700 K		●	

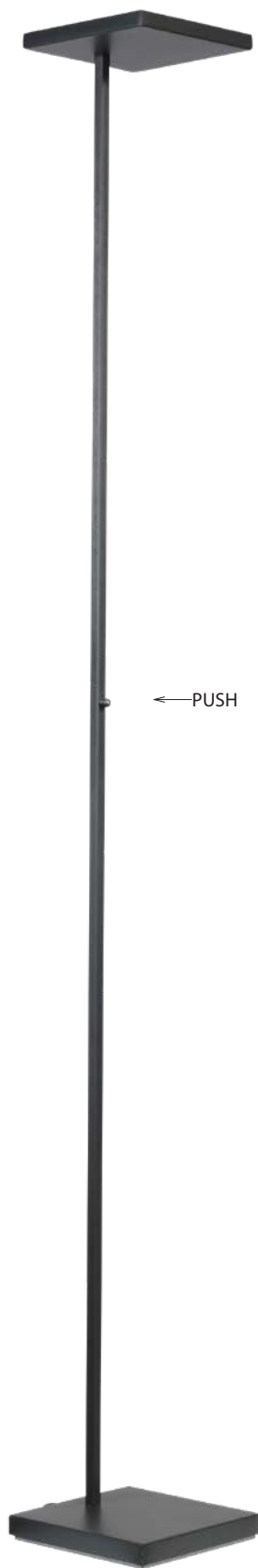

1883-....-DW



4882-....-DW

1882-....-DW

PRODUCT NUMBER	L	W	D	∅	SH	BH	TH	LW	LM	K	LS	DIM	
1882-....-DW		22 cm	22 cm	5-7 cm	1,5 cm		130 cm	6 w	720	2200/2700K		●	
1883-....-DW		20 cm	20 cm	20-20 cm	2,5 cm		185 cm	24 w	2880	2200/2700K		●	
4882-....-DW		16 cm	35 cm	5-7 cm	1,5 cm		60 cm	6 w	720	2200/2700K		●	

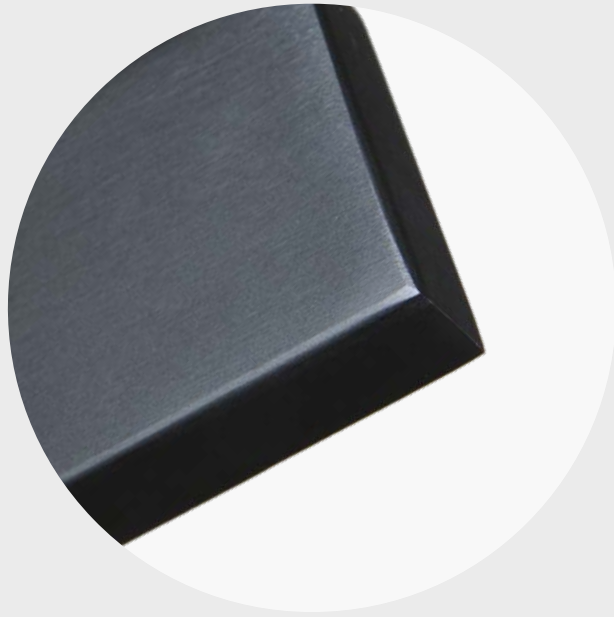



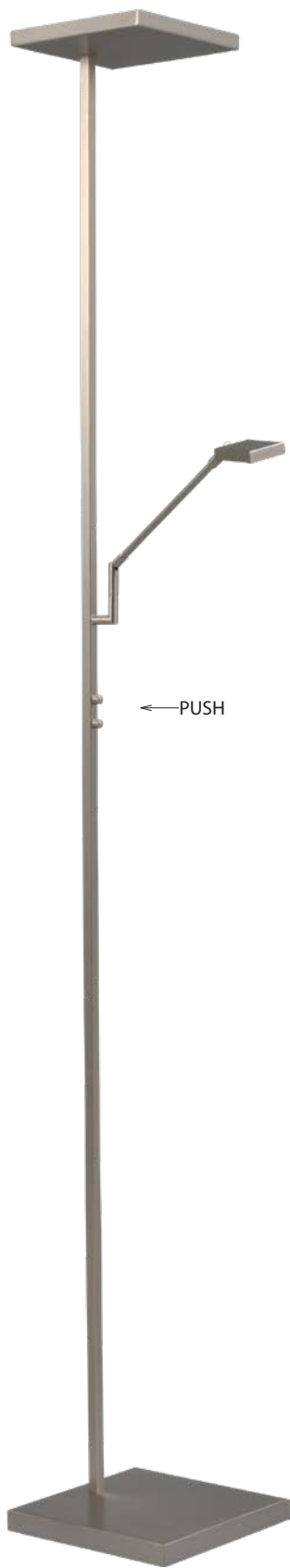

1886-....-DW



1884-....-DW



4884-....-DW

PRODUCT NUMBER	L	W	D	∅	SH	BH	TH	LW	LM	K	LS	DIM	
1886-....-DW		25 cm	68 cm	20-20 cm 5-7 cm	2,5 cm 1,5 cm		185 cm	24 w 6 w	2880 720	2200/2700 K		●	
1884-....-DW		22 cm	32 cm	5-7 cm	1,5 cm		130 cm	6 w	720	2200/2700 K		●	
4884-....-DW		16 cm	52 cm	5-7 cm	1,5 cm		70 cm	6 w	720	2200/2700 K		●	



# DENIA II

| Denia Round |

Dim to Warm | LED 5 YEAR WARRANTY

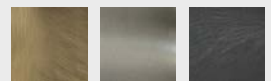

....-01 ....-37 ....-81

- Color options available for this collection - Fixture/Frame/Shade Color



4084-....-DW

1084-....-DW

4080-....-DW

1080-....-DW

PRODUCT NUMBER	L	W	D	∅	SH	BH	TH	LW	LM	K	LS	DIM	
1080-....-DW		25 cm	68 cm	7 cm	1,5 cm		150 cm	6 w	720	2200/2700K		●	
1084-....-DW		22 cm	32 cm	7 cm	1,5 cm		130 cm	6 w	720	2200/2700K		●	
4080-....-DW		16 cm	20 cm	7 cm	1,5 cm		65 cm	6 w	720	2200/2700K		●	
4084-....-DW		16 cm	52 cm	7 cm	1,5 cm		75 cm	6 w	720	2200/2700K		●	



5080-....-28-DW



5080-....-16-DW



1082-....-DW



4082-....-DW



1082-....-2-DW

PRODUCT NUMBER	L	W	D	∅	SH	BH	TH	LW	LM	K	LS	DIM	
1082-....-DW				7 cm	1,5 cm		130 cm	6 w	720	2200/2700 K		●	
1082-....-2-DW				7 cm	1,5 cm		130 cm	2x6 w	2x720	2200/2700 K		●	
4082-....-DW				7 cm	1,5 cm		60 cm	6 w	720	2200/2700 K		●	
5080-....-28-DW				28 cm	2,5 cm		27 cm	16 w	1920	2200/2700 K		○	
5080-....-16-DW				16 cm	2,5 cm		17,5 cm	8 w	960	2200/2700 K		○	



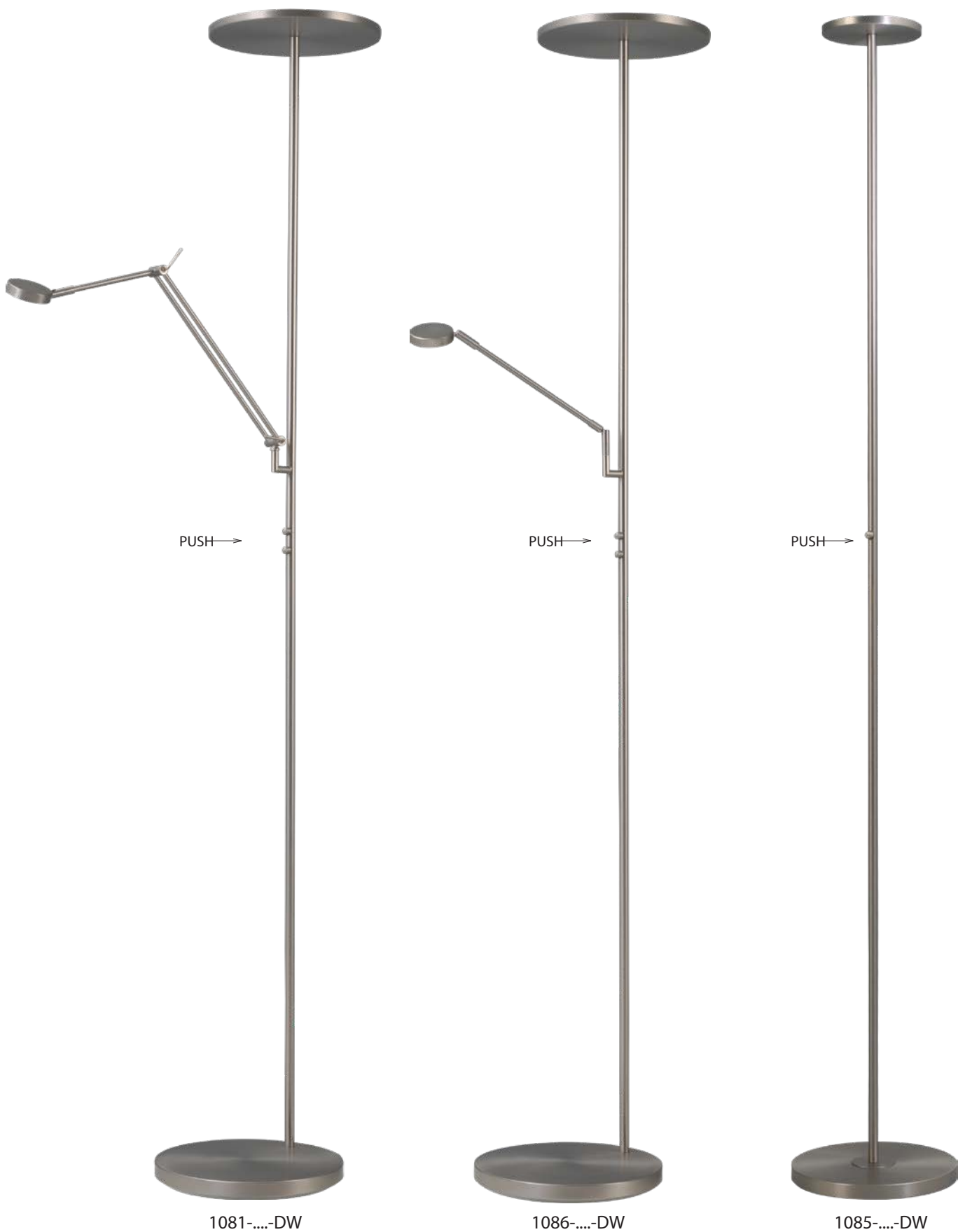

1081-....-DW

1086-....-DW

1085-....-DW

PRODUCT NUMBER	L	W	D	∅	SH	BH	TH	LW	LM	K	LS	DIM	
1081-....-DW		28 cm	68 cm	28 cm 7 cm	2,5 cm 1,5 cm		185 cm	23 w 6 w	2760 720	2200/2700K		●	
1085-....-DW				16 cm	2,5 cm		185 cm	12 w	1440	2200/2700K		●	
1086-....-DW		28 cm	68 cm	28 cm 7 cm	2,5 cm 1,5 cm		185 cm	23 w 6 w	2760 720	2200/2700K		●	

# DI MODA

SY0029962 | RECOMMENDED LED LIGHT BULB



....-05 ....-06 ....-37  
Shade Color

- Color options available for this collection -



5082-05



5085-05



5082-06



5085-06



5082-37



5085-37

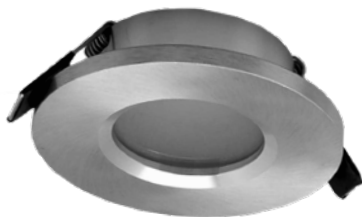

5094-37



5094-06

PRODUCT NUMBER	L	W	D	∅	SH	BH	TH	MW	LS	DIM	HS
5082-....				9,3 cm				1x18w	GU10	○	8 cm
5085-....		9 cm	9 cm					1x18w	GU10	○	8 cm
5094-....				8,5 cm				1x18w	GU10	○	6 cm

# ARKOS

Selection | Ceiling recessed

PREMIUM DEALER ARKOS | LED

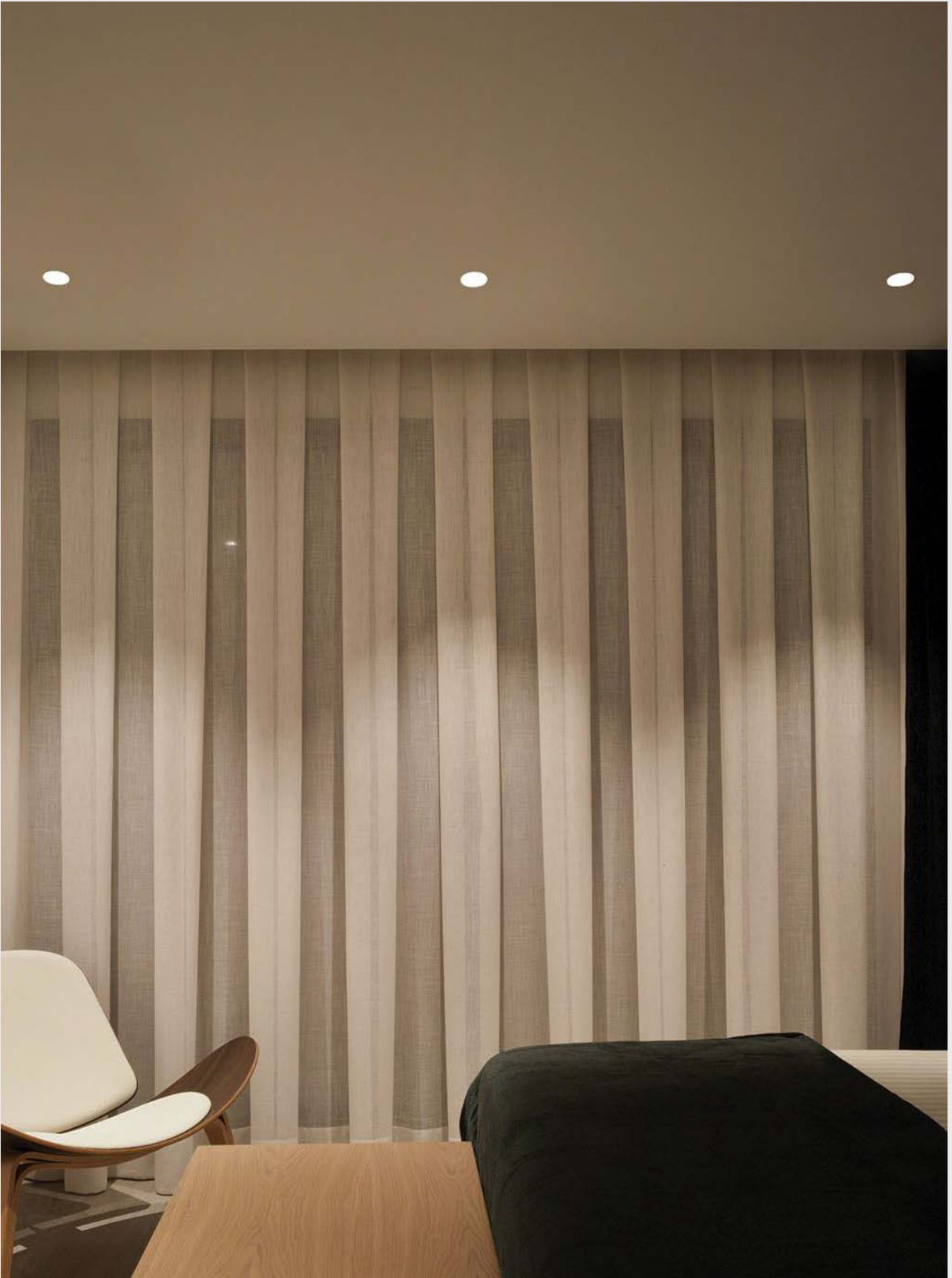

Information about this collection - ask for our Arkos Catalogue  
[www.masterlight.com/arkoslight](http://www.masterlight.com/arkoslight)

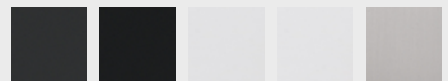

....-NT ....-N ....-WT ....-W ....-Z

- Color options available for this collection - Fixture/Frame/Shade Color  
There are more options and models in collection | Some series are also available in dim to warm 



SWAP M

A212-22-20-W  
WHITE



SWAP SQUARE

A254-32-20-N  
BLACK



SIX M RECESSED

A332-2-2-20-WT  
WHITE



PUCK M RECESSED

A313-10-2-0-NT  
BLACK



POP UP

A278-2-4-20-WT  
WHITE



TWIST 1

A204-12-20-NT  
BLACK

PRODUCT NUMBER	L	W	D	Ø	SH	BH	TH	LW	LM	K	LS	DIM	HS
A212-22-20-W				82mm				7w	910	2700k	phase cut	○	75mm
A254-32-20-N				92/92mm				7w	910	2700k	phase cut	○	85x85mm
A332-2-2-20-WT				89mm			80mm	17w	2050	2700k	dim dali	○	62mm
A313-10-2-0-NT				80mm			11,5mm	9w	1040	2700k	dim dali	○	73mm
A278-2-4-20-WT				42mm			7/61mm	6,5w	610	2700k	dim dali	○	79mm
A204-12-20-NT				132/132mm				7w	900	2700k	phase cut	○	119x119



# DONNA

SLF023850309 | RECOMMENDED LED LIGHT BULB



21

- Color options available for this collection - Fixture/Frame/Shade Color



2551-21



2550-21



3550-21



2552-21

PRODUCT NUMBER	L	W	D	Ø	SH	BH	TH	MW	LS	DIM
2550-21	90cm			65cm		60cm		5x18w	E14	○
2551-21	90cm			80cm		62cm		7x18w	E14	○
2552-21	90cm	129cm	70cm			67cm		10x18w	E14	○
3550-21		30cm					48cm	2x18w	E14	⊗

# DOPLER

Dopler | Bronze & Silver

RECOMMENDED LED LIGHT BULB

SY0026683



SY0026648



37

Fixture/Frame Color

- Color options available for this collection -

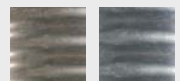

....-01 ....-37

Shade Color





1425-37-6271-....-25



4426-37-6271-....-25



4425-37-6271-....-17



3450-37-6271-....-17

PRODUCT NUMBER	L	W	D	∅	SH	BH	TH	MW	LS	DIM
1425-37-6271-....-25				25cm	45cm	130cm	175cm	18w	E27	⊗
3450-37-6271-....-17				17cm	26cm	15cm	34cm	18w	E27	⊗
4425-37-6271-....-17				17cm	26cm	27cm	53cm	18w	E27	⊗
4426-37-6271-....-25				25cm	45cm	37cm	82cm	18w	E27	⊗



2021-37-2-6270-....-55

PRODUCT NUMBER	L	W	D	∅	SH	BH	TH	MW	LS	DIM
2021-37-2-6270-....-55	123cm	165cm		26/55cm	31/45cm			2x18w	E27	○





2021-37-3-6270-....-35

PRODUCT NUMBER	L	W	D	∅	SH	BH	TH	MW	LS	DIM
2021-37-3-6270-....-35	110cm	145cm	15/35cm		18/25cm			3x18w	E27	○



2443-37-6270-....-35

1915-37-6270-....-55

PRODUCT NUMBER	L	W	D	∅	SH	BH	TH	MW	LS	DIM
1915-37-6270-....-55				26/55cm	31/45cm	131cm	162cm	18w	E27	●
2443-37-6270-....-35	112cm	126cm	35cm	15/35cm	18/25cm			3x18w	E27	○



2442-37-6270-....-35



2460-37-6270-....-55



4426-37-6270-....-35

PRODUCT NUMBER	L	W	D	∅	SH	BH	TH	MW	LS	DIM
2442-37-6270-....-35	112cm	113cm		15/35cm	18/25cm			2x18w	E27	○
2460-37-6270-....-55	112cm			26/55cm	31/45cm			18w	E27	○
4426-37-6270-....-35				15/35cm	18/25cm	37cm	82cm	18w	E27	⊗



← INCL. ACRYLIC DISC →

5460-37-6270-....-55



← INCL. ACRYLIC DISC →

5460-37-6270-....-45



← INCL. ACRYLIC DISC →

5460-37-6270-....-35



PRODUCT NUMBER	L	W	D	∅	SH	BH	TH	MW	LS	DIM
5460-37-6270-....-55				26/55 cm	31/45 cm			18 w	E27	○
5460-37-6270-....-45				17/45 cm	22/35 cm			18 w	E27	○
5460-37-6270-....-35				15/35 cm	18/25 cm			18 w	E27	○





# FLUTE

Dim to Warm | LED 5 YEAR WARRANTY



05

Fixture/Frame Color

- Color options available for this collection -



....-05



....-10



....-66

Shade Color



2590-....-DW



2592-....-35-6-DW



2592-....-50-12-DW

PRODUCT NUMBER	L	W	D	∅	SH	BH	TH	LS			DIM	
2590-....-DW	150 cm					50 cm	10 cm	1x4w	1x450	2200/2700k	○	
2592-....-35-6-DW	350 cm	35 cm						6x4w	6x450	2200/2700k	○	
2592-....-50-12-DW	350 cm	50 cm						12x4w	12x450	2200/2700k	○	

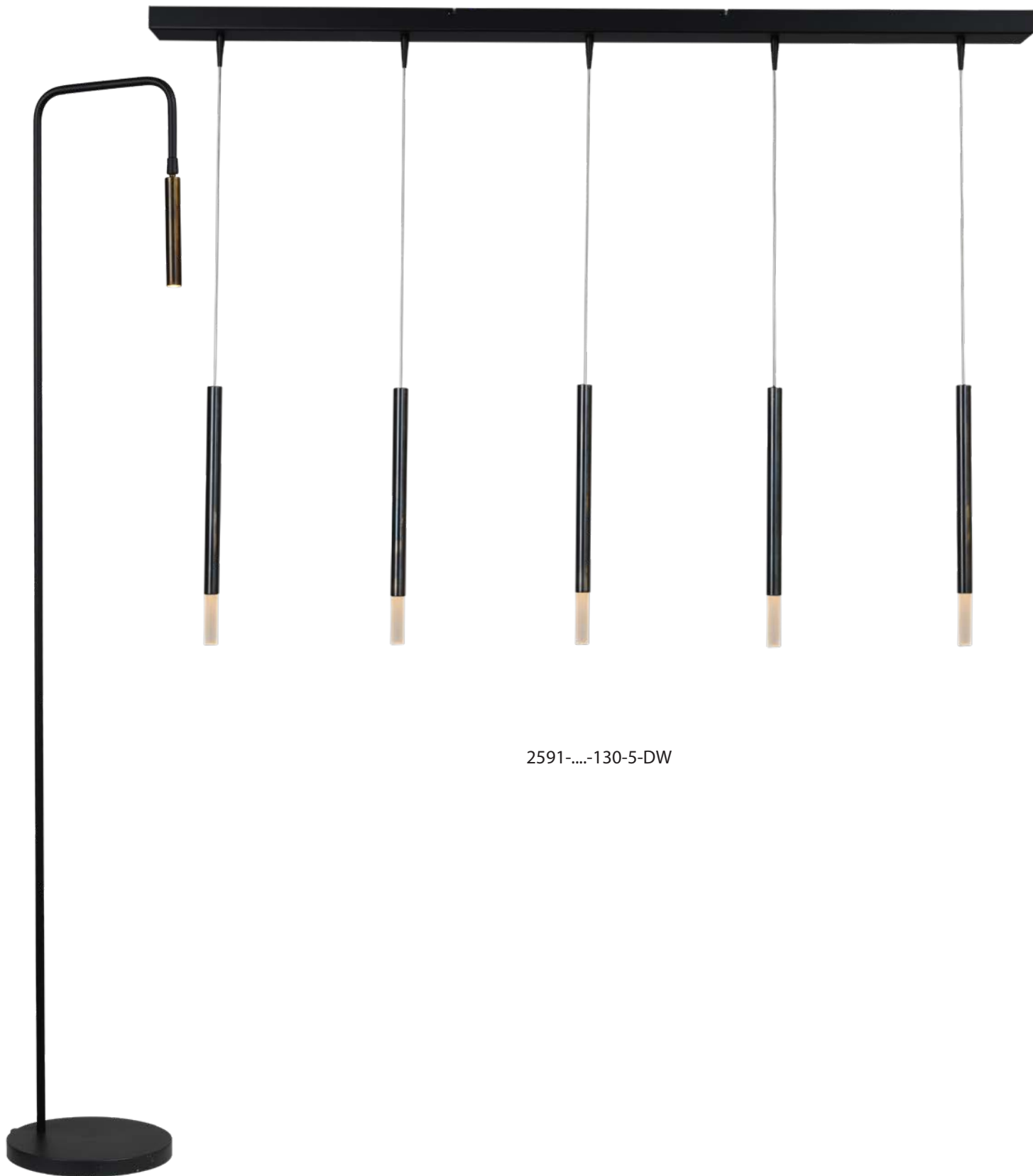

1590-....-DW

2591-....-130-5-DW

PRODUCT NUMBER	L	W	D	∅	SH	BH	TH	LW	LM	K	LS	DIM	
1590-....-DW		36 cm						1x4w	1x450	2200/2700k		<input checked="" type="checkbox"/>	
2591-....-130-5-DW	150 cm	130 cm						5x4w	5x450	2200/2700k		<input type="checkbox"/>	



2591-....-100-4-DW



5590-....-16-3-DW



4590-....-DW

PRODUCT NUMBER	L	W	D	∅	SH	BH	TH	LW	LM	K	LS	DIM	
2591-....-100-4-DW	150cm	100cm						4x4w	4x450	2200/2700K		<input type="radio"/>	
4590-....-DW			15cm				52cm	1x4w	450	2200/2700K		<input checked="" type="radio"/>	
5590-....-16-3-DW		36cm						3x4w	3x450	2200/2700K		<input type="radio"/>	

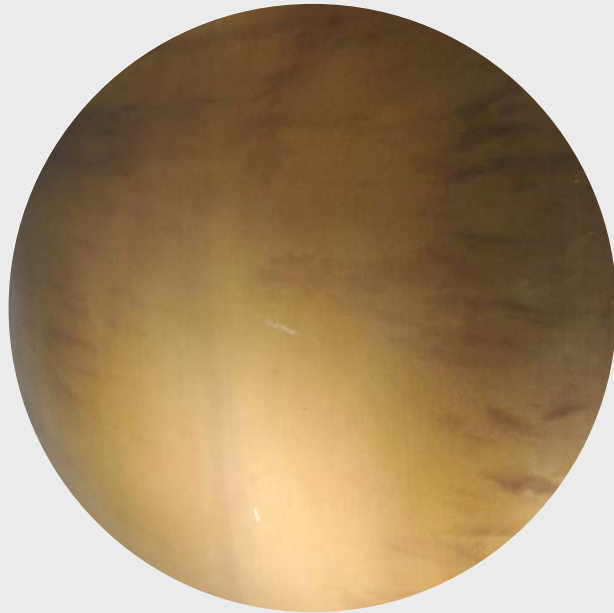





# G I O

Dim to Warm | LED 5 YEAR WARRANTY



05

Fixture/Frame Color

- Color options available for this collection -



176

Shade Color



5916-05-176-DW



5915-05-176-DW



3915-05-176-DW

PRODUCT NUMBER	L	W	D	∅	SH	BH	TH	LW	LM	K	LS	DIM	
3915-05-176-DW		36 cm				50 cm	10 cm	3x2W	3x150	2200/2700K		●	
5915-05-176-DW				72 cm		32 cm	10 cm	5x2W	5x150	2200/2700K		○	
5916-05-176-DW		156 cm	65 cm			22 cm	10 cm	7x2W	7x150	2200/2700K		○	

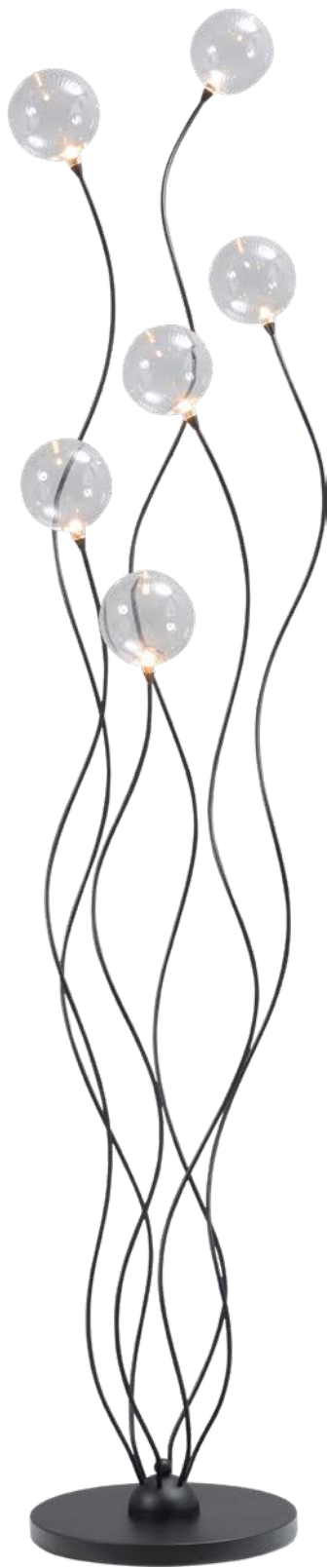

1915-05-176-DW



2915-05-176-DW



4916-05-176-DW

PRODUCT NUMBER	L	W	D	∅	SH	BH	TH	LW	LM	K	LS	DIM	
1915-05-175-DW			40 cm	10 cm	10 cm		174 cm	6x2w	6x150	2200/2700K		●	
2915-05-176-DW	70-140 cm	150 cm	65 cm	10 cm	10 cm			8x2w	8x150	2200/2700K		●	
4916-05-176-DW			33 cm	10 cm	10 cm		58 cm	5x2w	5x150	2200/2700K		●	





2916-05-176-DW



4915-05-176-DW

PRODUCT NUMBER	L	W	D	∅	SH	BH	TH	LW	LM	K	LS	DIM	
2916-05-176-DW	70-140cm	180cm	80cm	10cm	10cm			12x2w	12x150	2200/2700K		●	
4915-05-176-DW			31cm	10cm	10cm		47cm	3x2w	3x150	2200/2700K		●	



# IOTA

Dim to Warm | LED 5 YEAR WARRANTY



81

Fixture/Frame Color

- Color options available for this collection -

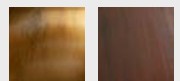

....-10 ....-25  
Shade Color

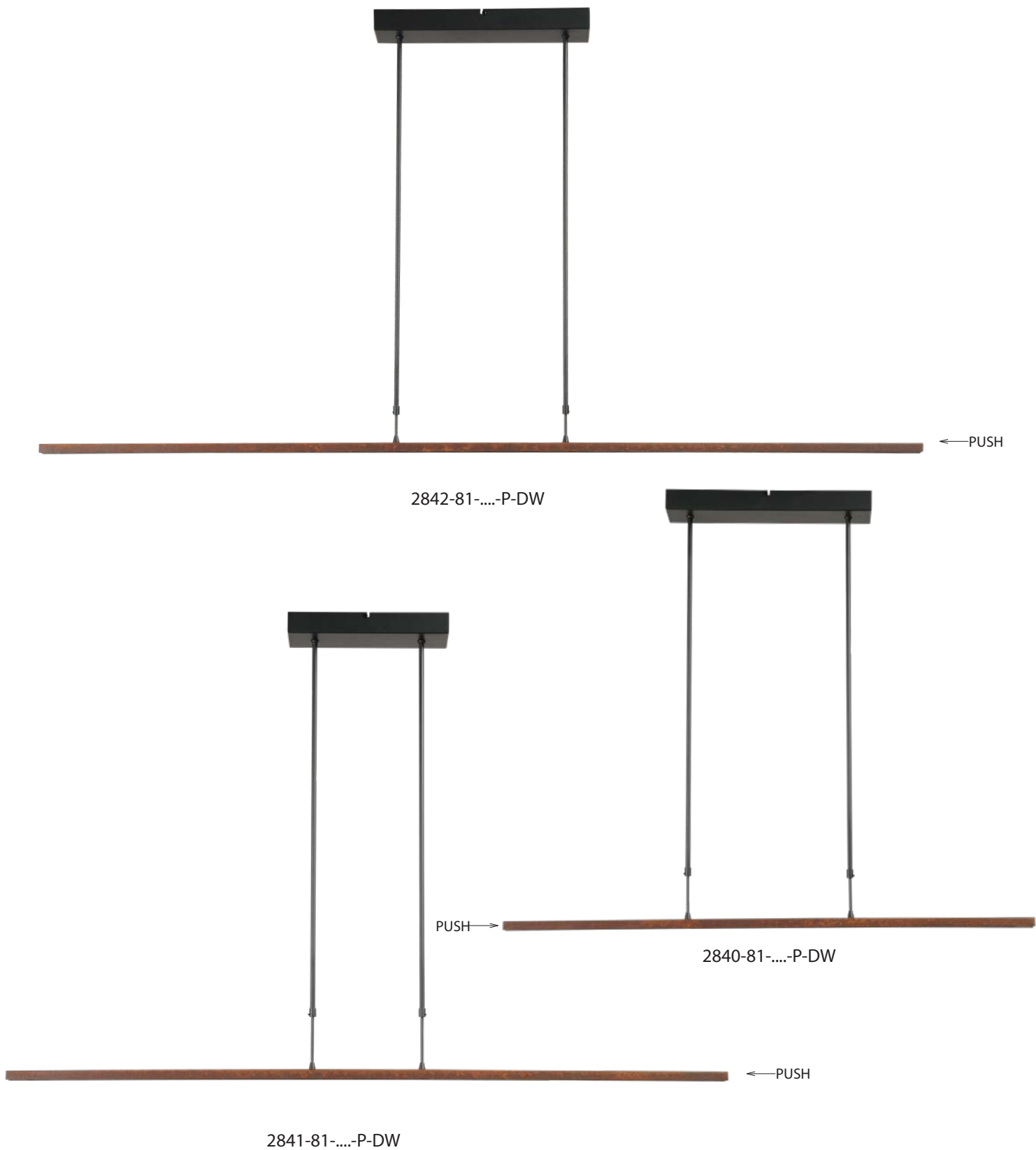

PRODUCT NUMBER	L	W	D	∅	SH	BH	TH	LW	LM	K	LS	DIM	
2840-81-....-P-DW	78-145 cm	100 cm	3 cm					26 w	3120	2200/2700 K		●	
2841-81-....-P-DW	78-145 cm	130 cm	3 cm					32 w	3840	2200/2700 K		●	
2842-81-....-P-DW	78-145 cm	160 cm	3 cm					45 w	5400	2200/2700 K		●	

# MELANI

Dim to Warm | LED 5 YEAR WARRANTY

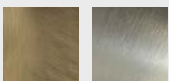

01-.... 37-....  
Fixture/Frame Color

- Color options available for this collection -



06  
Shade Color



2480-....-06-DW



2483-....-06-35-3-DW



2483-....-06-50-6-DW

PRODUCT NUMBER	L	W	D	∅	SH	BH	TH	LW	LM	K	LS	DIM	
2480-....-06-DW	150cm	11cm	11cm	18+6,5cm	5,5cm			4w	450	2200/2700K		<input type="checkbox"/>	
2483-....-06-35-3-DW	150cm	35cm	35cm	18+6,5cm	5,5cm			3x4w	3x450	2200/2700K		<input type="checkbox"/>	
2483-....-06-50-6-DW	150cm	50cm	50cm	18+6,5cm	5,5cm			6x4w	6x450	2200/2700K		<input type="checkbox"/>	



1484-....-06-DW

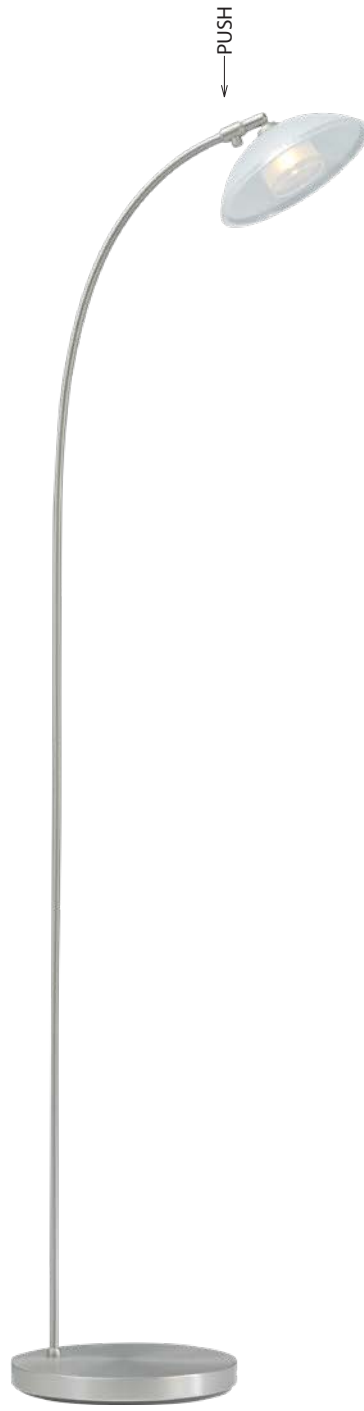

1483-....-06-DW



5481-....-06-70-3-DW



5480-....-06-DW

PRODUCT NUMBER	L	W	D	∅	SH	BH	TH	LW	LM	K	LS	DIM	
1483-....-06-DW			35 cm	18+6,5 cm	5,5 cm		130 cm	4 w	450	2200/2700K		●	
1484-....-06-DW			50 cm	18+6,5 cm	5,5 cm		180 cm	2x4 w	2x450	2200/2700K		●	
5480-....-06-DW	18 cm			18+6,5 cm	5,5 cm	9 cm	17 cm	4 w	450	2200/2700K		○	
5481-....-06-70-3-DW	70 cm			18+6,5 cm	5,5 cm		17 cm	3x4 w	3x450	2200/2700K		○	





2481-....-06-100-3-DW



3480-....-06-DW



4481-....-06-DW

PRODUCT NUMBER	L	W	D	∅	SH	BH	TH	LW	LM	K	LS	DIM	
2481-....-06-100-3-DW	150cm	100cm		18+6,5cm	5,5cm			3x4w	3x450	2200/2700K			
3480-....-06-DW			24cm	18+6,5cm	5,5cm		13cm	4w	450	2200/2700K			
4481-....-06-DW			28cm	18+6,5cm	5,5cm		44cm	4w	450	2200/2700K			

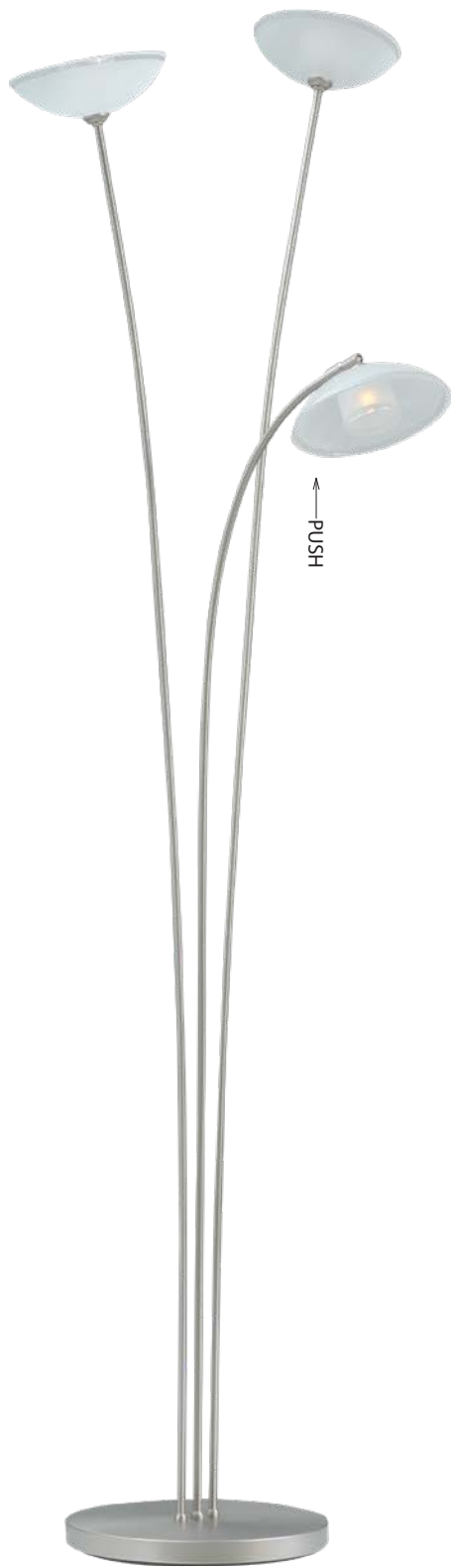

1485-....-06-DW



2481-....-06-70-2-DW

PRODUCT NUMBER	L	W	D	∅	SH	BH	TH	LW	LM	K	LS	DIM	
1485-....-06-DW		58 cm		18+6,5 cm	5,5 cm		180 cm	3x4 w	3x450	2200/2700K		●	
2481-....-06-70-2-DW	150 cm	70 cm	18 cm	18+6,5 cm	5,5 cm			2x4 w	2x450	2200/2700K		○	



2481-....-06-130-4-DW



4480-....-06-DW

4482-....-06-DW

PRODUCT NUMBER	L	W	D	∅	SH	BH	TH	LW	LM	K	LS	DIM	
2481-....-06-130-4-DW	150cm	130cm	18cm	18+6,5cm	5,5cm		130cm	4x4w	4x450	2200/2700K			
4480-....-06-DW				18+6,5cm	5,5cm		41cm	4w	450	2200/2700K			
4482-....-06-DW				18+6,5cm	5,5cm		30cm	4w	450	2200/2700K			

# METALLICO

SY0029962 | RECOMMENDED LED LIGHT BULB

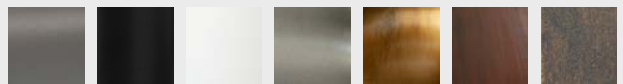

....-00 ....-05 ....-06 ....-37 ....-10 ....-25 ....-35

- Color options available for this collection -Fixture/Frame/Shade Color



3045-06



3045-05



3045-00



3045-37



3045-25



3045-10



3045-35

PRODUCT NUMBER	L	W	D	∅	SH	BH	TH	MW	LS	DIM
3045 - ....		10 cm	6 cm			22 cm		2x18w	GU10	○





3046-06



3046-05



3046-00



3046-37



3046-25



3046-10



3046-35

PRODUCT NUMBER	L	W	D	∅	SH	BH	TH	MW	LS	DIM
3046 - ....		10cm	6cm			12cm		1x18w	GU10	○



# ARKOS

Selection | Wall

PREMIUM DEALER ARKOS | LED

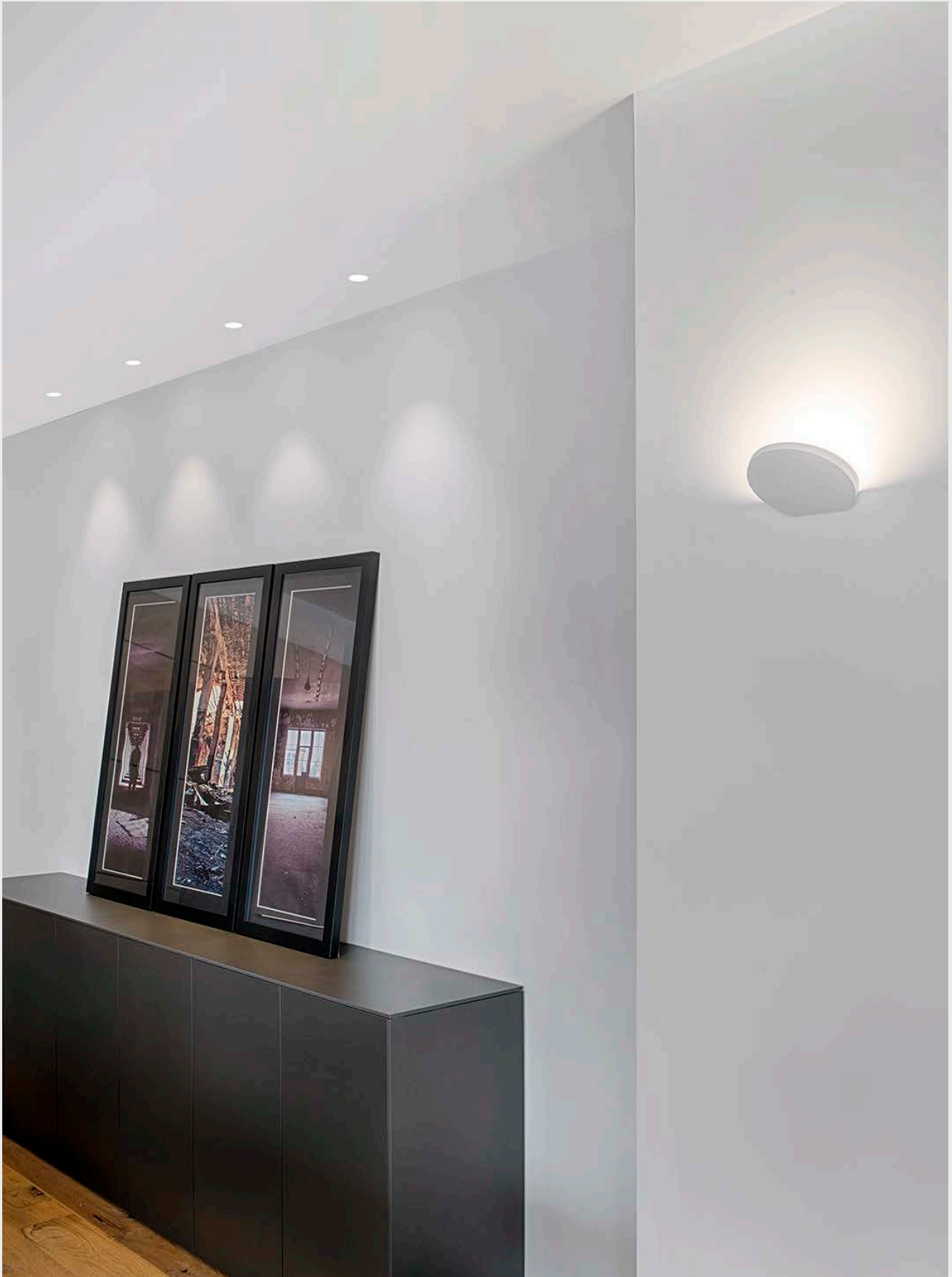

Information about this collection - ask for our Arkos Catalogue  
[www.masterlight.com/arkoslight](http://www.masterlight.com/arkoslight)

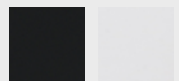

....-NT ....-WT

- Color options available for this collection - Fixture/Frame/Shade Color



REC MINI

A308-00-10-WT  
WHITE



REC

A256-00-2-0-NT  
BLACK



FLAP

A332-2-2-20-WT  
WHITE



LIP

A288-00-10-NT  
BLACK



REC MINI DIUBLE

A310-00-2-0-NT  
BLACK



REC DOUBLE

A309-00-2-0-WT  
WHITE

PRODUCT NUMBER	L	W	D	∅	SH	BH	TH	LW	LM	K	LS	DIM
A308-00-10-WT			176/40mm				40mm	20w	2450	2700k		
A256-00-2-0-NT			352/148mm				40mm	39,5w	5200	2700k	dim dali	○
A240-00-10-WT			180/136mm				105mm	20w	1875	2700k		
A288-00-10-NT			232/90mm				90mm	24w	2970	2700k	dim dali	○
A310-00-2-0-NT			177/110mm				58mm	16,5w	2300	2700k	dim dali	○
A309-00-2-0-WT			354/110mm				58mm	29,5w	4150	2700k	dim dali	○

A small selection / there ar more options available

# MIKA

Dim to Warm | LED 5 YEAR WARRANTY

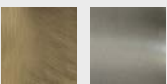

....-01 ....-37

Fixture/Frame Color

- Color options available for this collection -



06

Shade Color



PRODUCT NUMBER	L	W	D	∅	SH	BH	TH	LW	LM	K	LS	DIM	
2390-....-06-DW	80-145 cm			60 cm	5,5 cm			23 w	2760	2200/2700 K		●	
2395-....-06-DW	80-145 cm	80 cm		50 cm	5,5 cm			23 w	2760	2200/2700 K		●	



# MILAN

Dim to Warm | LED 5 YEAR WARRANTY



BUILT-IN  
LED

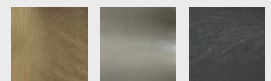

....-01 ....-37 ....-81

- Color options available for this collection - Fixture/Frame/Shade Color



PRODUCT NUMBER	L	W	D	∅	SH	BH	TH	LW	LM	K	LS	DIM	
1361-....-10-DW			68 cm	30 cm	2,5 cm		185 cm	23 w	2760	2200/2700K		●	
				10 cm	1,5 cm			6 w	720				
1366-....-DW				30 cm	2,5 cm		185 cm	23 w	2760	2200/2700K		●	
				7 cm	1,5 cm			6 w	720				
5360-16-....-DW				18 cm	2,5 cm		17,5 cm	8 w	960	2200/2700K		○	
5360-28-....-DW				30 cm	2,5 cm		27 cm	16 w	1920	2200/2700K		○	

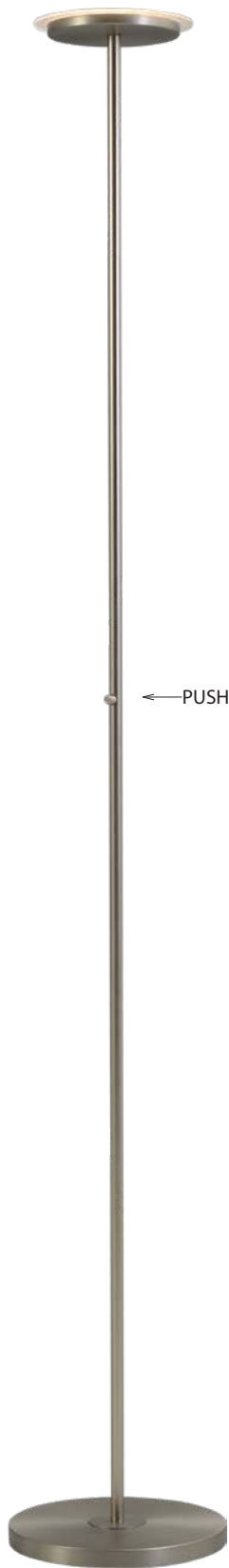

1365-....-DW



2362-....-100-3-DW  
'Not available in color -81'

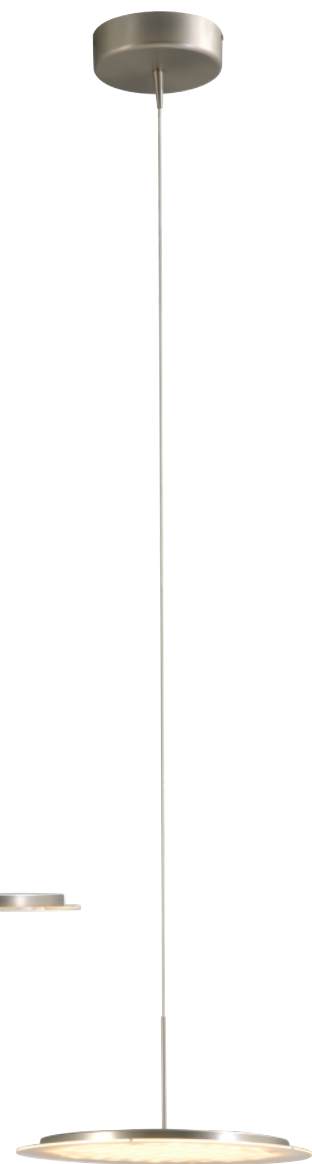

2360-....-28-DW

PRODUCT NUMBER	L	W	D	∅	SH	BH	TH	LW	LM	K	LS	DIM	
1365-....-DW				18cm	2,5cm		185cm	12w	1440	2200/2700K		●	
2362-....-100-3-DW	150cm	100cm		18cm	2,5cm			3x8w	3x960	2200/2700K		○	
2360-28-DW	150cm			30cm	2,5cm			16w	1920	2200/2700K		○	



2362-....-130-4-DW  
 'Not available in color -81'

2360-....-16-DW

PUSH →

3361-....-DW

PRODUCT NUMBER	L	W	D	∅	SH	BH	TH	LW	LM	K	LS	DIM	
2360-....-16-DW	150cm			18cm	2,5cm			8w	960	2200/2700K		●	
3361-....-DW			22cm	18cm	2,5cm	11cm		8w	960	2200/2700K		○	
2362-....-130-4-DW	150cm	130cm		18cm	2,5cm			4x8w	4x960	2200/2700K		○	







# MODERN CROWN

Dim to Warm | LED 5 YEAR WARRANTY



05

- Color options available for this collection - Fixture/Frame/Shade Color



PUSH →

2571-05-DW

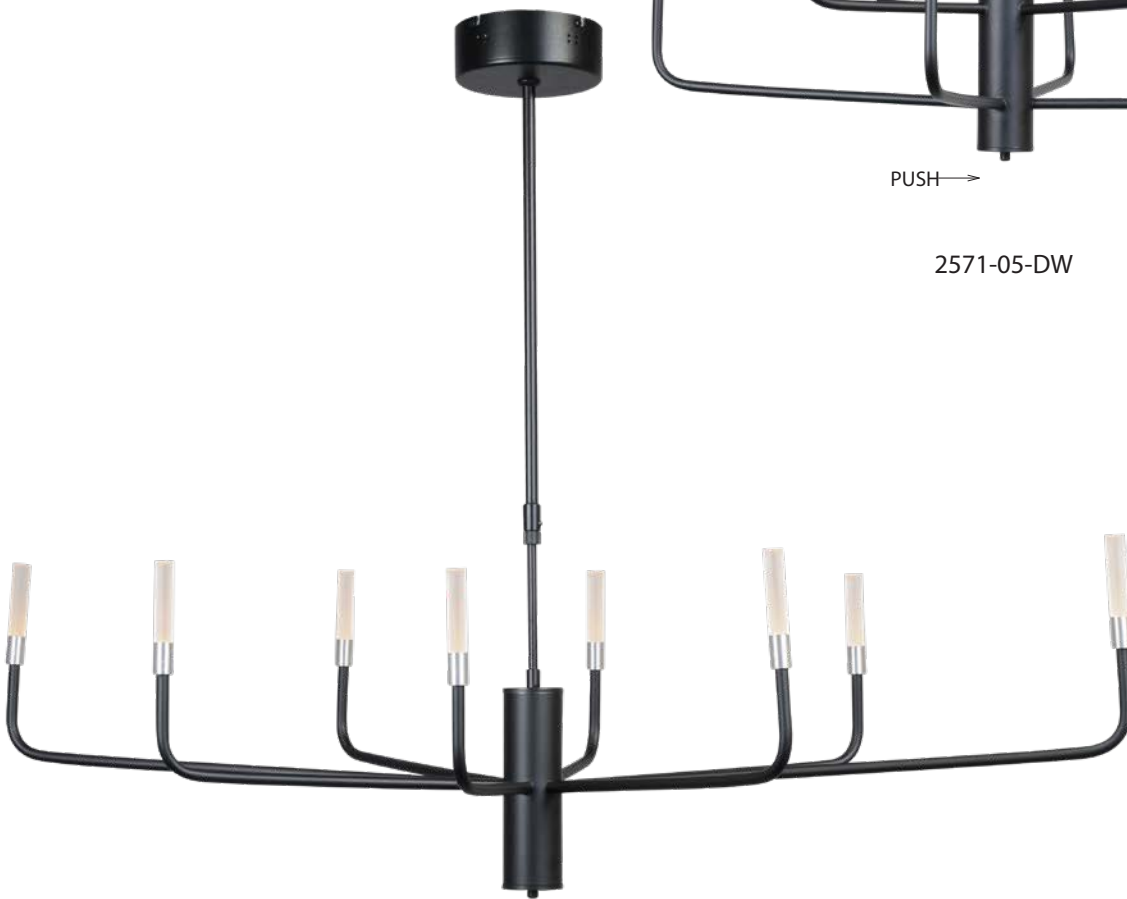

PUSH →

2570-05-DW

PRODUCT NUMBER	L	W	D	∅	SH	BH	TH	LW	LM	K	LS	DIM	
2571-05-DW	75-115 cm	115 cm	65 cm	65 cm		70 cm		8x4 w	8x450	2200/2700K		●	
2570-05-DW	75-115 cm	115 cm	65 cm	120 cm		40 cm		8x4 w	8x450	2200/2700K		●	

# MOLTO II

Dim to Warm | LED 5 YEAR WARRANTY



01

Fixture/Frame Color

- Color options available for this collection -



134

Shade Color



5698-01-134-DW



5696-01-134-DW



5695-01-134-DW

PRODUCT NUMBER	L	W	D	∅	SH	BH	TH	LW	LM	K	LS	DIM	
5695-01-134-DW			63 cm	4 cm	5,5 cm		28 cm	5x150	5x2w	2200/2700K		<input type="radio"/>	
5696-01-134-DW			65 cm	4 cm	5,5 cm		30 cm	10x150	10x2w	2200/2700K		<input type="radio"/>	
5698-01-134-DW	115 cm		65 cm	4 cm	5,5 cm		43 cm	10x150	10x2w	2200/2700K		<input type="radio"/>	



1695-01-134-DW



2695-01-134-DW



4695-01-134-DW

PRODUCT NUMBER	L	W	D	∅	SH	BH	TH	LW	LM	K	LS	DIM	
1695-01-134-DW		40 cm	40 cm	5,5 cm	4 cm		178 cm	7x2w	7x150	2200/2700K		●	
2695-01-134-DW	75-115 cm	115 cm	65 cm	5,5 cm	4 cm	40 cm		10x2w	10x150	2200/2700K		●	
4695-01-134-DW		22 cm	22 cm	5,5 cm	4 cm		44 cm	3x2w	3x150	2200/2700K		●	





2696-01-134-DW



3695-01-134-DW

PRODUCT NUMBER	L	W	D	∅	SH	BH	TH	LW	LM	K	LS	DIM	
3695-01-134-DW		27 cm	17 cm	4 cm	5,5 cm	47 cm		3x2w	3x150	2200/2700K		●	
2696-01-134-DW	75-115 cm	135 cm	65 cm	4 cm	5,5 cm	40 cm		14x2w	14x150	2200/2700K		●	



# MOLTO III

Dim to Warm | LED 5 YEAR WARRANTY



37

Fixture/Frame Color

- Color options available for this collection -



176

Shade Color



5698-37-176-5



5696-37-176-5



3695-37-176-5

PRODUCT NUMBER	L	W	D	∅	SH	BH	TH	LW	LM	K	LS	DIM	
3695-37-176-DW		22 cm	22 cm	10 cm	10 cm	44 cm		3x2w	3x150	2200/2700K		●	
5696-37-176-DW			65 cm	10 cm	10 cm	30 cm		10x2w	10x150	2200/2700K		○	
5698-37-176-DW	115 cm		65 cm	10 cm	10 cm	43 cm		10x2w	10x150	2200/2700K		○	



1695-37-176-DW



2695-37-176-DW



4695-37-176-DW





PRODUCT NUMBER	L	W	D	∅	SH	BH	TH	LW	LM	K	LS	DIM	
1695-37-176-DW		40 cm	40 cm	10 cm	10 cm	178 cm		7x2w	7x150	2200/2700K		●	
2695-37-176-DW	75-115 cm	115 cm	65 cm	10 cm	10 cm	40 cm		10x2w	10x150	2200/2700K		●	
4695-37-176-DW		22 cm	22 cm	10 cm	10 cm	44 cm		3x2w	3x150	2200/2700K		●	



2696-37-176-DW



1696-37-176-DW

PRODUCT NUMBER	L	W	D	∅	SH	BH	TH	LW	LM	K	LS	DIM	
1696-37-175-DW			40cm	10cm	10cm		174cm	6x2w	6x150	2200/2700K		●	
2696-37-176-DW	75-115cm	135cm	65cm	10cm	10cm	40cm		14x2w	10x150	2200/2700K		●	



“Light affects everything you see  
and how you see light is affected by everything”.

---







# MOSKOW

SLF023850309 | RECOMMENDED LED LIGHT BULB



37

- Color options available for this collection - Fixture/Frame/Shade Color



2377-37

PRODUCT NUMBER	L	W	D	Ø	SH	BH	TH	MW	LS	DIM
2377-37	90cm			92cm	69cm			10x18w	E14	○



5375-37



2375-37



3375-37

PRODUCT NUMBER	L	W	D	∅	SH	BH	TH	MW	LS	DIM
2375-37	90cm			68cm	50cm			5x18w	E14	○
3375-37		40cm	23cm			38cm		2x18w	E14	⊗
5375-37				70cm		31cm		5x18w	E14	○



2376-37



3376-37



4375-37

PRODUCT NUMBER	L	W	D	Ø	SH	BH	TH	MW	LS	DIM
2376-37	90cm			87cm	69cm			6x18w	E14	○
3376-37		40cm	20cm			38cm		18w	E14	⊗
4375-37				26cm		41cm		18w	E14	⊗



# O . A . K

| Real Wood |

Dim to Warm | LED 5 YEAR WARRANTY

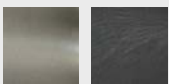
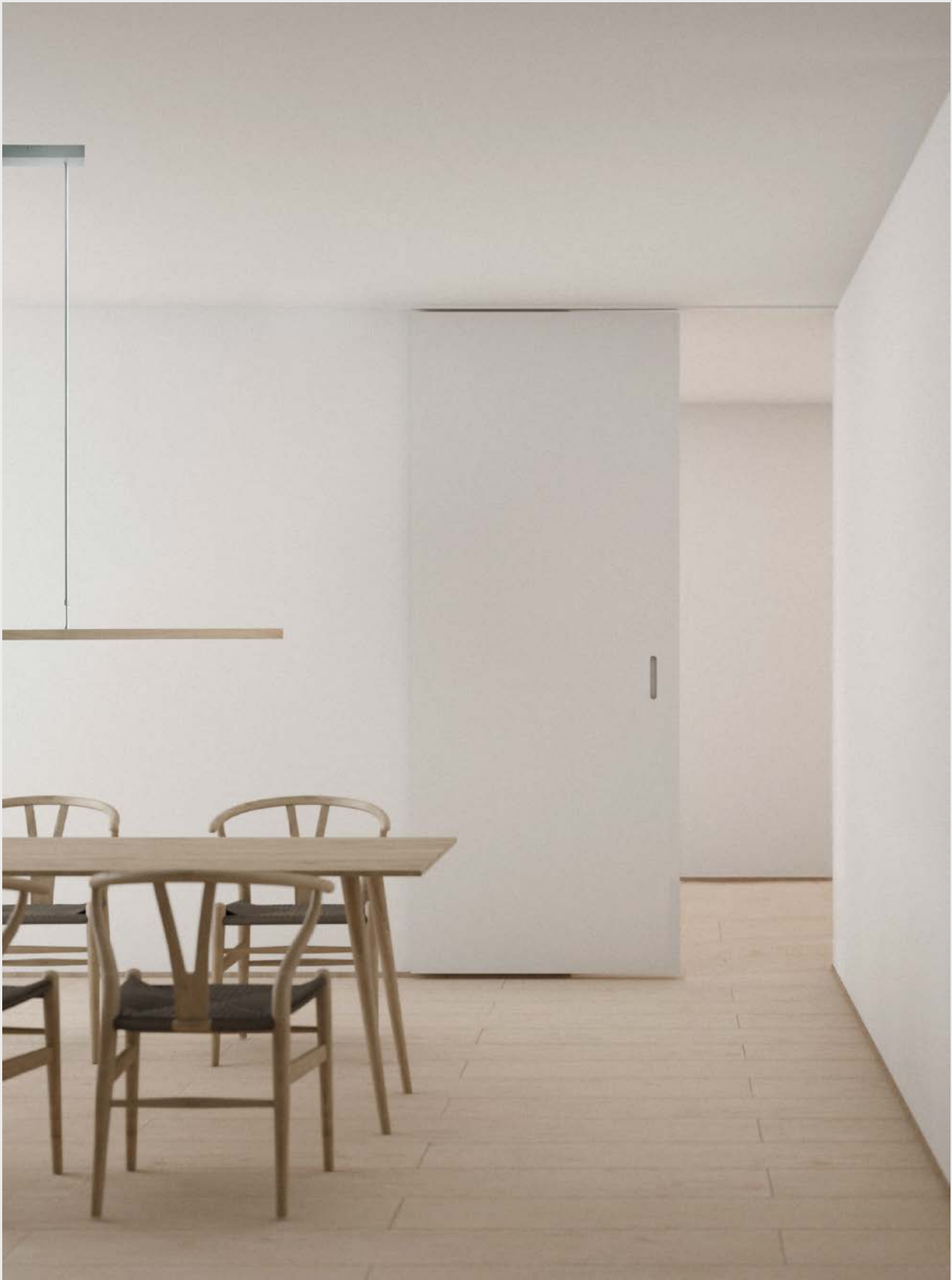

37-.... 81-....

Fixture/Frame Color

- Color options available for this collection -





....-BL ....-NA

Shade Color



2787-81-NA-P-DW

PRODUCT NUMBER	L	W	D	∅	SH	BH	TH	LW	LM	K	LS	DIM	
2787-81-NA-P-DW	78-145 cm	164 cm			3 cm			45 w	5400	2200/2700k			





2787-....-....-P-DW



2785-....-....-P-DW

2786-....-....-P-DW

PRODUCT NUMBER	L	W	D	∅	SH	BH	TH	LW	LM	K	LS	DIM	
2785-....-....-P-DW	78-145 cm	104 cm			3 cm			26 w	3120	2200/2700K		●	
2786-....-....-P-DW	78-145 cm	134 cm			3 cm			32 w	3840	2200/2700K		●	
2787-....-....-P-DW	78-145 cm	164 cm			3 cm			45 w	5400	2200/2700K		●	



# OBLICA

Sphere | Square | Cylinder

RECOMMENDED LED LIGHT BULB  
SY0026947  
SY002668

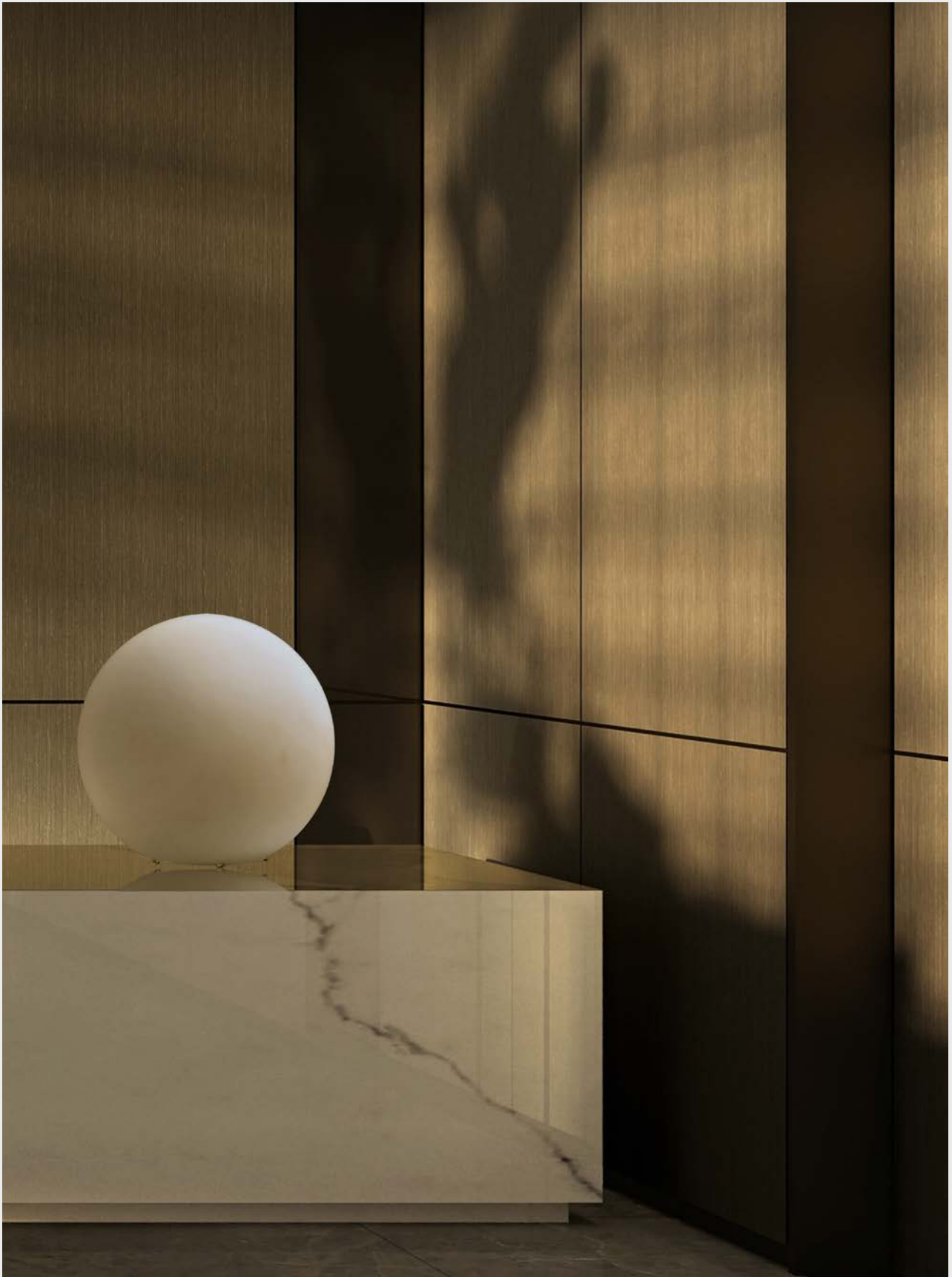

37

Fixture/Frame Color

- Color options available for this collection -



06

Shade Color



4010-06-30



4016-37-06



4017-37-06



4010-06-25



4505-37-06



4506-37-06



4010-06-20

PRODUCT NUMBER	L	W	D	∅	SH	BH	TH	MW	LS	DIM
4010-06-20				20cm			18cm	18w	E27	⊗
4010-06-25				25cm			23cm	18w	E27	⊗
4010-06-30				30cm			28cm	18w	E27	⊗
4016-37-06				11x11cm	20cm		23cm	18w	E27	⊗
4017-37-06				11x11cm	28cm		31cm	18w	E27	⊗
4505-37-06				10cm	25cm		29cm	18w	E27	⊗
4506-37-06				10cm	35cm		39cm	18w	E27	⊗

# OVUM

| Vigo II |

Dim to Warm | LED 5 YEAR WARRANTY

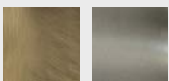

01-.... 37-....

Fixture/Frame Color

- Color options available for this collection -



....-05 ....-06

Shade Color

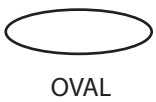

PRODUCT NUMBER	L	W	D	∅	SH	BH	TH	LW	LM	K	LS	DIM	
2636-.....-DW	78-145 cm	140 cm			3 cm			42 w	5040	2200/2700k		●	



# PLAFONNIERE

Modern | Plafonniere | Classic

Dim to Warm | LED 5 YEAR WARRANTY

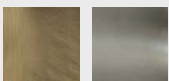

01-.... 37-....

Fixture/Frame Color

- Color options available for this collection -



06

Shade Color



SY002668 | RECOMMENDED LED LIGHT BULB



5021-06-DW 

5021-06



5022-06-DW 

5022-06



5023-06-DW 

5023-06



5024-06-DW 

5024-06

PRODUCT NUMBER	L	W	D	∅	SH	BH	TH	LW	LM	K	LS	DIM
5021-06-DW				25cm	9cm		11cm	9w	1080	2200/2700K		○
5021-06				25cm	9cm		11cm	18w			E27	○
5022-06-DW				30cm	9cm		11cm	9w	1080	2200/2700K		○
5022-06				30cm	9cm		11cm	2X18w			E27	○
5023-06-DW				35cm	11cm		13cm	19w	2160	2200/2700K		○
5023-06				35cm	11cm		13cm	2x18w			E27	○
5024-06-DW				40cm	11cm		13cm	19w	2160	2200/2700K		○
5024-06				40cm	11cm		13cm	2x18w			E27	○



5130-....-06-DW 

5130-....-06



5145-....-06-DW 

5145-....-06



5135-....-06-DW 

5135-....-06



5146-....-06-DW 

5146-....-06



5140-....-06-DW 

5140-....-06



5147-....-06-DW 

5147-....-06

PRODUCT NUMBER	L	W	D	∅	SH	BH	TH	LW	LM	K	LS	DIM
5130/5145-....-06-DW				30cm	9cm		11cm	9w	1080	2200/2700K		<input type="radio"/>
5130/5145-....-06				30cm	9cm		11cm	2x18w			€27	<input type="radio"/>
5135/5146-....-06-DW				35cm	9cm		11cm	19w	2160	2200/2700K		<input type="radio"/>
5135/5146-....-06				35cm	9cm		11cm	2x18w			€27	<input type="radio"/>
5140/5147-....-06-DW				40cm	11cm		13cm	19w	2160	2200/2700K		<input type="radio"/>
5140/5147-....-06				40cm	11cm		13cm	2x18w			€27	<input type="radio"/>

# ARKOS

Selection | Surface

PREMIUM DEALER ARKOS | LED



ceiling light  
selection

Information about this collection - ask for our Arkos Catalogue  
[www.masterlight.com/arkoslight](http://www.masterlight.com/arkoslight)

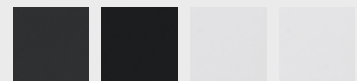

....-NT ....-N ....-WT ....-W

- Color options available for this collection - Fixture/Frame/Shade Color  
A small selection / there are more options available



STRAM SURFACE

A246-03-2-1-WT  
WHITE



BLOCK

A270-13-4-1-N  
BLACK



PUCK M

A251-10-00-WT  
WHITE



SKY 2

A195-02-4-1-WT  
WHITE



IO SURFACE

A263-00-20-WT  
WHITE



BLACK FOSTER SURFACE 5

A320-40-2-0-NT  
BLACK

PRODUCT NUMBER	L	W	D	∅	SH	BH	TH	LW	LM	K	LS	DIM
A246-03-2-1-WT				220mm			107mm	22w	3025	3000k	dim dali	○ Push/1-10v
A270-13-4-1-N				175/175mm				22w	3000	3000k	dim dali	○
A251-10-00-WT				80mm			54mm	12w	960	2700k		
A195-02-4-1-WT				300mm			87mm	15w	2450	3000k	dim dali	○
A263-00-20-WT				84mm			74mm	4,5w	485	2700k		
A320-40-2-0-NT				132/132mm				7w	900	2700k	dim dali	○

for all the specifications see the Arkos Catalogue



# REAL II

| Real Down |

Dim to Warm | LED 5 YEAR WARRANTY

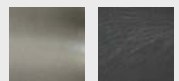

....-37 ....-81



- Color options available for this collection - Fixture/Frame/Shade Color

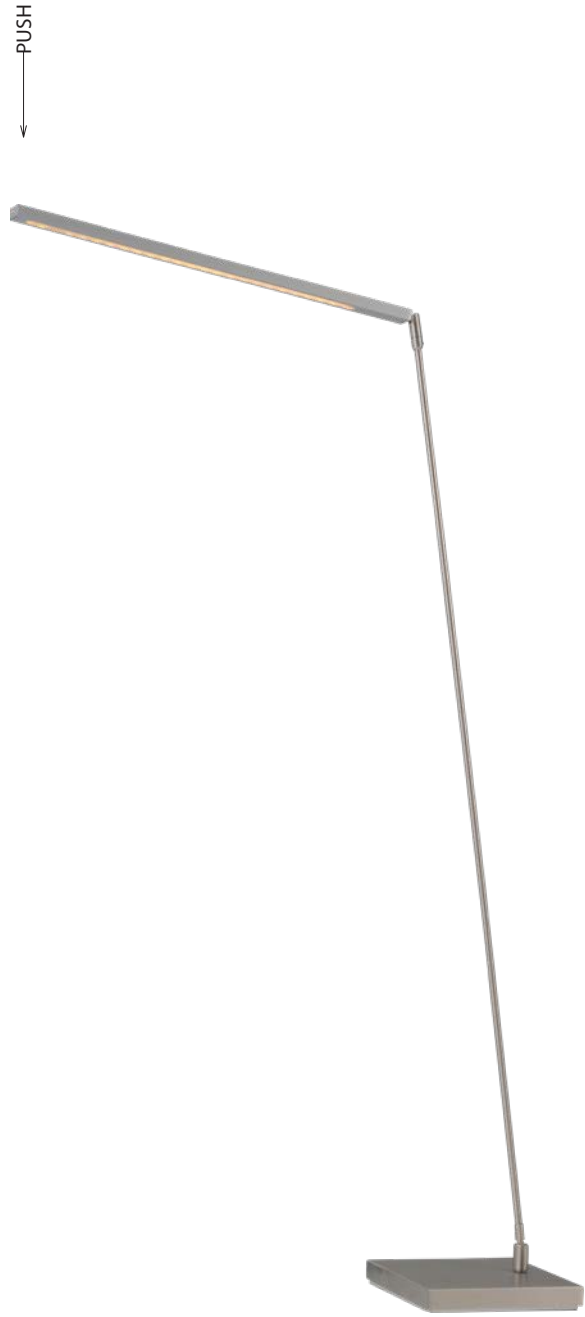

1775-....-P-DW





1774-....-P-DW

PRODUCT NUMBER	L	W	D	∅	SH	BH	TH	LW	LM	K	LS	DIM	
1774-....-P-DW		22 cm	95 cm				170 cm	13 w	1560	2200/2700K		●	
1775-....-P-DW		22 cm	22 cm				165 cm	32 w	3840	2200/2700K		●	



2778-....-P-DW

PRODUCT NUMBER	L	W	D	∅	SH	BH	TH	LW	LM	K	LS	DIM	
2778-....-P-DW	78-145 cm	200 cm			1,5 cm			52 w	6240	2200/2700k			



2777-....-P-DW

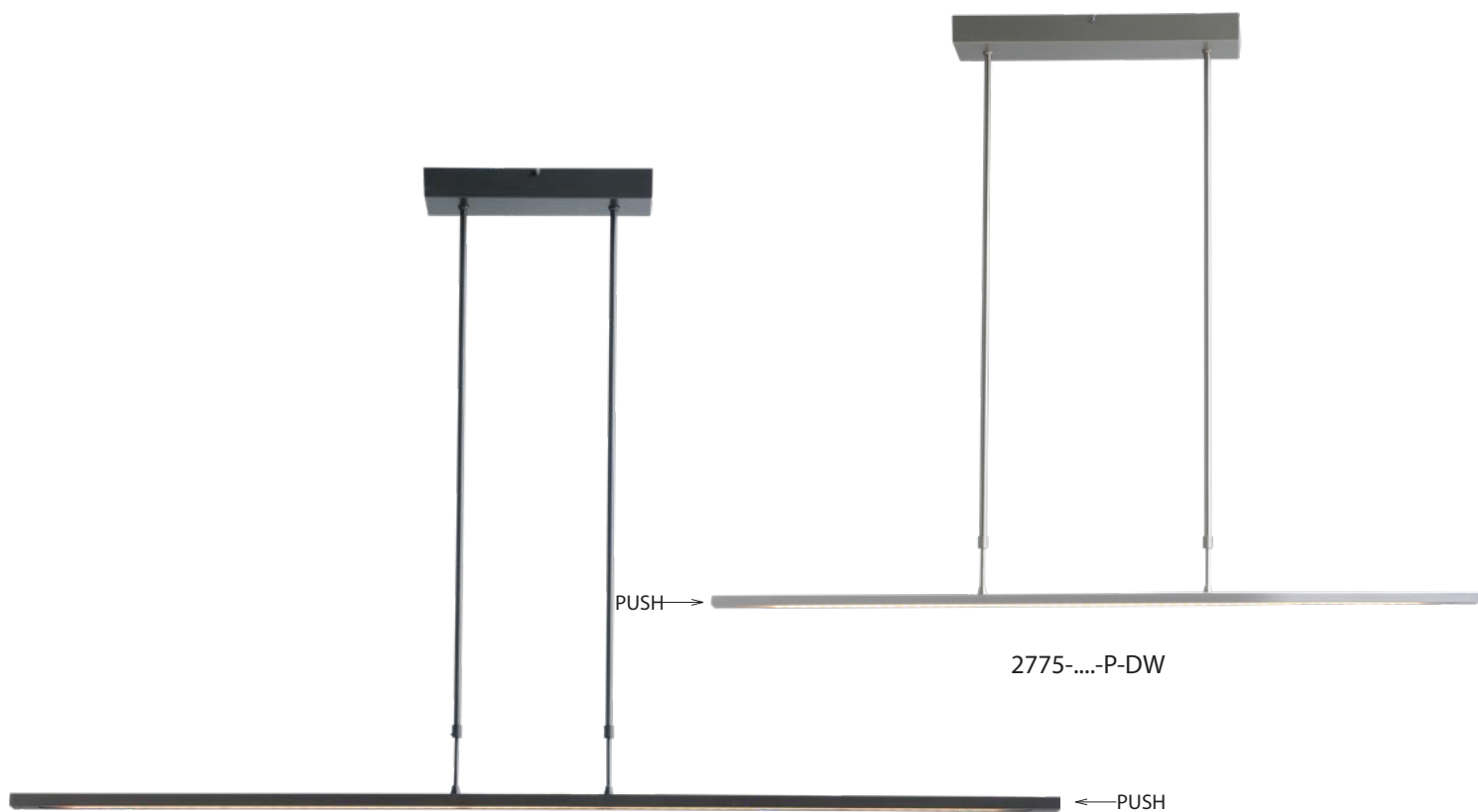

2775-....-P-DW

2776-....-P-DW

PRODUCT NUMBER	L	W	D	∅	SH	BH	TH	LW	LM	K	LS	DIM	
2775-....-P-DW	78-145 cm	100 cm			1,5 cm			26 w	3120	2200/2700 K		●	
2776-....-P-DW	78-145 cm	130 cm			1,5 cm			32 w	3840	2200/2700 K		●	
2777-....-P-DW	78-145 cm	160 cm			1,5 cm			45 w	5400	2200/2700 K		●	

# REAL III

| Real Up+Down |

Dim to Warm | LED 5 YEAR WARRANTY

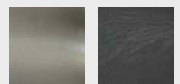

....-37 ....-81

- Color options available for this collection - Fixture/Frame/Shade Color



2977-....-S-P-DW  
2977-....-S-2xP-DW

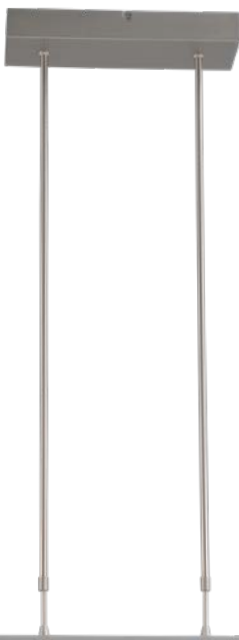

2976-....-S-P-DW  
2976-....-S-2xP-DW



PRODUCT NUMBER	L	W	D	∅	SH	BH	TH	LW	LM	K	LS	DIM	
2975-....-S-P-DW 2975-....-S-2xP-DW	78-145cm	100cm			3cm			38w	4560	2200/2700k		●	
2976-....-S-P-DW 2976-....-S-2xP-DW	78-145cm	130cm			3cm			44w	5280	2200/2700k		●	
2977-....-S-P-DW 2977-....-S-2xP-DW	78-145cm	160cm			3cm			57w	6840	2200/2700k		●	

This collection also has the option of two push dimmer | Switching apart from above and below light -2xP







# ROMA

SLF023850309 | RECOMMENDED LED LIGHT BULB

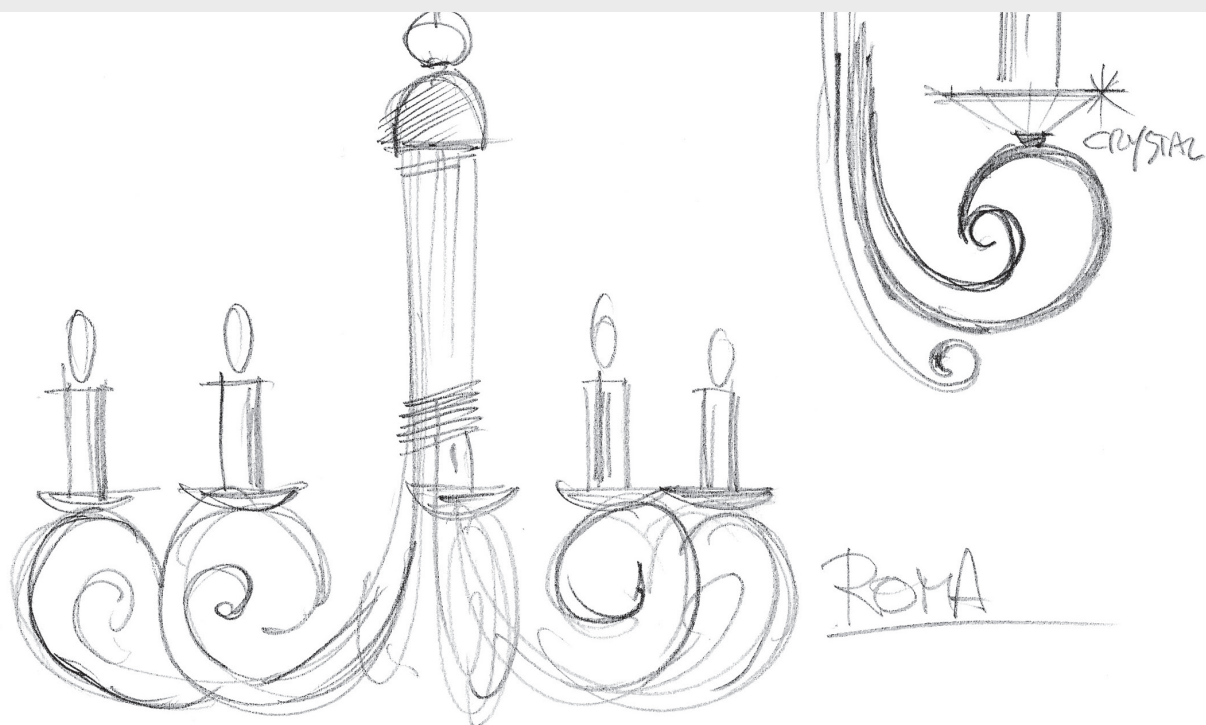

5 LIGHTS

ROMA

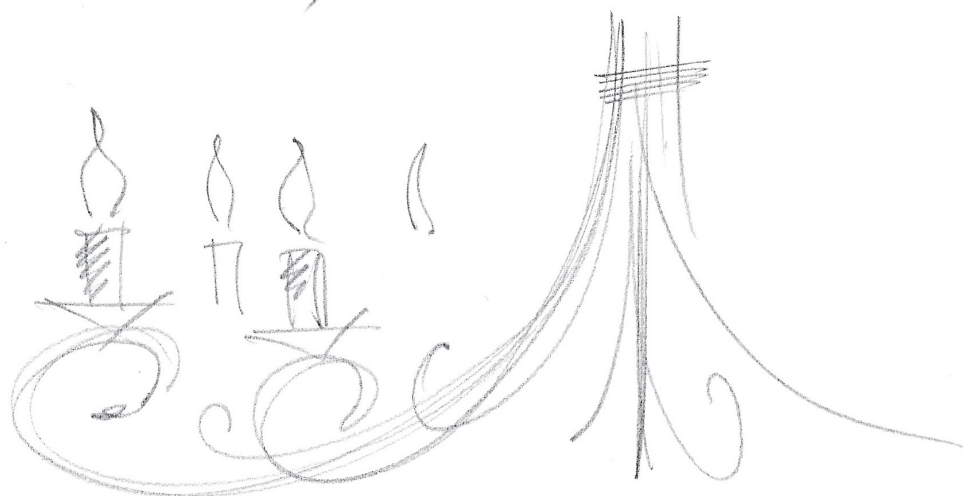

12 LIGHTS



2 LIGHTS



....-21

- Color options available for this collection - Fixture/Frame/Shade Color



2558-21



4555-21

PRODUCT NUMBER	L	W	D	∅	SH	BH	TH	MW	LS	DIM
2558-21	90cm	110cm	66cm			60cm		12x18w	E14	○
4555-21		37cm					43cm	2x18w	E14	⊗





5555-21



2557-21



3556-21

PRODUCT NUMBER	L	W	D	∅	SH	BH	TH	MW	LS	DIM
2557-21	90cm	86cm	86cm			62cm		12x18w	E14	○
3556-21		25cm	26cm				55cm	2x18w	E14	⊗
5555-21		50cm	50cm				60cm	6x18w	E14	○



2555-21



2556-21



3555-21

PRODUCT NUMBER	L	W	D	Ø	SH	BH	TH	MW	LS	DIM
2555-21	90cm	50cm	50cm			53cm		6x18w	E14	○
2556-21	90cm	68cm	68cm			58cm		9x18w	E14	○
3555-21			26cm				40cm	18w	E14	⊗



# SOLTA

SLF023860409 | RECOMMENDED LED LIGHT BULB



37

Fixture/Frame Color

- Color options available for this collection -



00

Shade Color



4670-37-00



2670-37-00



2672-37-00-35-3

PRODUCT NUMBER	L	W	D	∅	SH	BH	TH	MW	LS	DIM
2672-37-35-3	150cm	35cm		15cm	33cm			3x18w	E27	○
2670-37-00	150cm	11cm		15cm	33cm			18w	E27	○
4670-37-00				15cm	33cm		56cm	18w	E27	⊗



1670-37-00



2671-37-00-130-4



3670-37-00

PRODUCT NUMBER	L	W	D	∅	SH	BH	TH	MW	LS	DIM
2671-37-00-130-4	150cm	130cm		15cm	33cm			4x18w	E27	○
1670-37-00				15cm	33cm		165cm	18w	E27	⊗
3670-37-00			24cm	15cm	33cm			18w	E27	⊗



2671-37-00-100-3

2671-37-00-70-2

PRODUCT NUMBER	L	W	D	∅	SH	BH	TH	MW	LS	DIM
2671-37-00-100-3	150cm	100cm		15cm	33cm			3x18w	E27	○
2671-37-00-70-2	150cm	70cm		15cm	33cm			2x18w	E27	○

# TERRA

Dim to Warm | LED 5 YEAR WARRANTY



SY0026648 | RECOMMENDED LED LIGHT BULB



37

Fixture/Frame Color

- Color options available for this collection -



06

Shade Color



1620-37-DW

1622-37-DW

1626-37-DW

1625-37-DW

PRODUCT NUMBER	L	W	D	∅	SH	BH	TH	LW	LM	K	LS	DIM	
1620-37-DW				18cm	101cm		183cm	39w 18w	4700	2200/2700K		●	
1622-37-DW				18cm	101cm		112cm	39w	4700	2200/2700K		●	
1626-37-DW				18cm	108cm		197cm	39w	4700	2200/2700K		●	
1625-37-DW				18cm	108cm		112cm	39w	4700	2200/2700K		●	



# TONDO

SY0026683 | RECOMMENDED LED LIGHT BULB

SY0026648

SY0026648

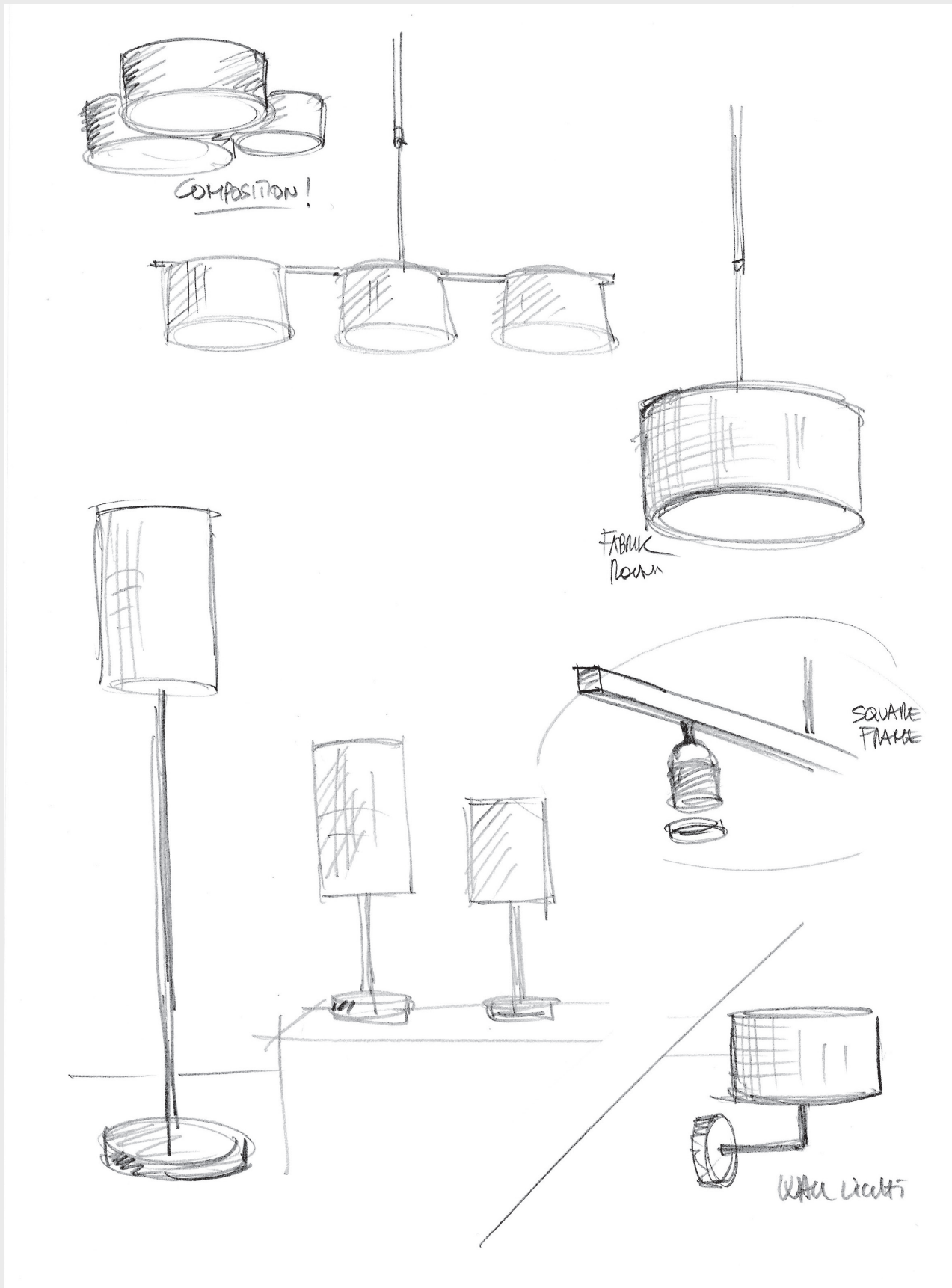

37

Fixture/Frame Color

- Color options available for this collection -



....-01



....-20



....-82

Shade Color



5460-37-6560-....-55  
INCL. ACRYLIC DISC



5460-37-6560-....-40  
INCL. ACRYLIC DISC



5460-37-6560-....-45  
INCL. ACRYLIC DISC



4425-37-6560-....-18



4426-37-6560-....-25



1425-37-6560-....-25

PRODUCT NUMBER	L	W	D	∅	SH	BH	TH	MW	LS	DIM
1425-37-6560-....-25				25cm	45cm	130cm	175cm	18w	E27	⊗
4426-37-6560-....-25				25cm	45cm	37cm	82cm	18w	E27	⊗
4425-37-6560-....-18				18cm	25cm	27cm	54cm	18w	E27	⊗
5460-37-6560-....-55				55cm	20cm	12cm	24cm	18w	E27	○
5460-37-6560-....-45				45cm	20cm	12cm	24cm	18w	E27	○
5460-37-6560-....-40				40cm	20cm	12cm	24cm	18w	E27	○

# TORCELLO

SY0026648 | SY0026947 | RECOMMENDED LED LIGHT BULB



22

Fixture/Frame Color

- Color options available for this collection -



43

Shade Color



“Light makes atmosphere”

---



PRODUCT NUMBER	L	W	D	∅	SH	BH	TH	MW	LS	DIM
2681-22-43	95-150cm	80cm		30cm	10cm			2x18w	E27	○
2682-22-43	95-150cm	110cm		30cm	10cm			3x18w	E27	○
3681-22-43			18cm	13cm	8cm		16,5cm	18w	G9	○
5680-22-43				30cm	10cm		13,5cm	18w	E27	○
5681-22-43				40cm	12,5cm		16cm	2x18w	E27	○



2683-22-43



2680-22-43



1681-22-43



4681-22-43

PRODUCT NUMBER	L	W	D	∅	SH	BH	TH	MW	LS	DIM
1681-22-43		75 cm		40 cm	12,5 cm		181 cm	18 W	E27	●
2680-22-43	95-150 cm			22 cm	9 cm			18 W	E27	○
2683-22-43	95-150 cm	78 cm		40 cm	12,5 cm			18 W	E27	○
4681-22-43				22 cm	9 cm			5 x 18 W	E27	○
				30 cm	10 cm		42,5 cm	18 W	E27	⊗



# VERONA

| Verona I |

SY0026648 | SY0026947 | RECOMMENDED LED LIGHT BULB



21

Fixture/Frame Color

- Color options available for this collection -



51

Shade Color



2479-21-51



2475-21-51



1475-21-51

PRODUCT NUMBER	L	W	D	∅	SH	BH	TH	MW	LS	DIM
1475-21-51		49 cm		40 cm 17 cm	13,5 cm 8 cm		182 cm	18 W 18 W	E27	●
2475-21-51	80-115 cm			40 cm	13,5 cm			18 W	E27	○
2479-21-51	80-115 cm	63 cm		17 cm	8 cm			5x18 W	E27	○



2477-21-51



2476-21-51



3476-21-51

PRODUCT NUMBER	L	W	D	∅	SH	BH	TH	MW	LS	DIM
2476-21-51	80-135 cm	92 cm		30 cm	10,5 cm			2x18 W	E27	○
2477-21-51	80-135 cm	111 cm		30 cm	10,5 cm			3x18 W	E27	○
3476-21-51		13 cm		17 cm	8 cm		28 cm	18 W	E27	⊗



5495-21-51



5496-21-51



2478-21-51



4475-21-51

PRODUCT NUMBER	L	W	D	∅	SH	BH	TH	MW	LS	DIM
2478-21-51	80-135 cm	135 cm		30 cm	10,5 cm			4x18 W	E27	○
4475-21-51				30 cm	10,5 cm		50 cm	18 W	E27	⊗
5495-21-51				30 cm	10,5 cm		13 cm	18 W	E27	○
5496-21-51				40 cm	13,5 cm		18 cm	2x18 W	E27	○

# VESTO

SY0028006 | RECOMMENDED LED LIGHT BULB



37

Fixture/Frame Color

- Color options available for this collection -



00

Shade Color



1511-37-00



2510-37-00



2512-37-00-50-3

PRODUCT NUMBER	L	W	D	∅	SH	BH	TH	MW	LS	DIM
1511-37-00				19,5 cm	25 cm		159 cm	18 w	E27	●
2510-37-00	150 cm			19,5 cm	25 cm			18 w	E27	○
2512-37-00-50-3	150 cm	50 cm		19,5 cm	25 cm			3x18 w	E27	○





2511-37-00-130-4



4510-37-00

PRODUCT NUMBER	L	W	D	∅	SH	BH	TH	MW	LS	DIM
2511-37-00-130-4	150cm	100cm		19,5cm	25cm			4x18w	E27	○
4510-37-00				19,5cm	25cm		66cm	18w	E27	⊗



2511-37-00-100-3

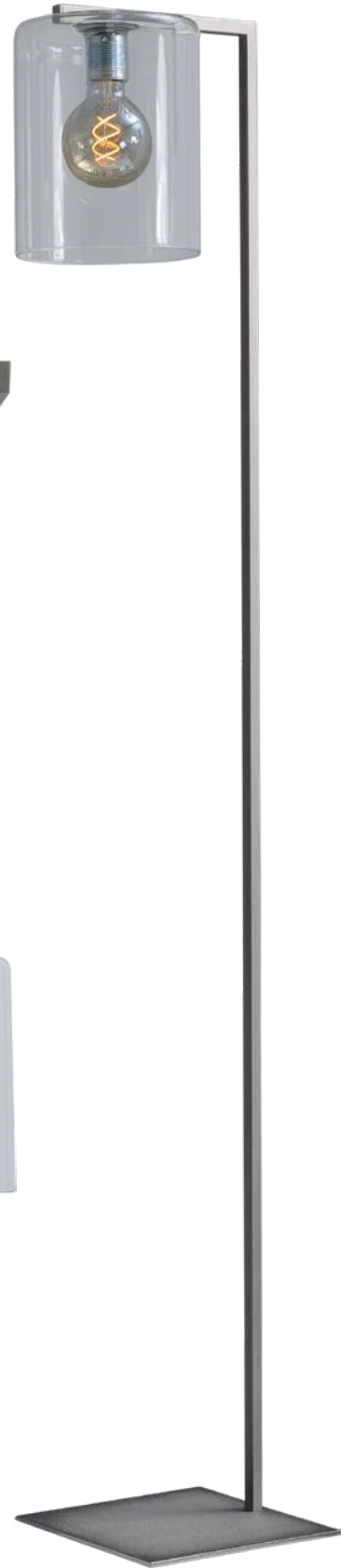

1510-37-00

PRODUCT NUMBER	L	W	D	∅	SH	BH	TH	MW	LS	DIM
1510-37-00		35 cm		19,5 cm	25 cm		159 cm	18 w	E27	⊗
2511-00-37-100-3	150 cm	100 cm		19,5 cm	25 cm			3x18 w	E27	○

# VIGO

Dim to Warm | LED 5 YEAR WARRANTY

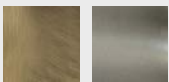

01-.... 37-....

Fixture/Frame Color

- Color options available for this collection -



....-05 ....-06

Shade Color



2630-01-....-DW  
100cm

2631-01-....-DW  
130cm

2632-01-....-DW  
170cm

PRODUCT NUMBER	L	W	D	∅	SH	BH	TH	LW	LM	K	LS	DIM	
2630-01-....-DW	78-145cm	100cm		10cm	3cm			26w	3120	2200/2700k		●	
2631-01-....-DW	78-145cm	130cm		10cm	3cm			34w	4080	2200/2700k		●	
2632-01-....-DW	78-145cm	170cm		10cm	3cm			42w	5040	2200/2700k		●	



2630-37-....-DW





2631-37-....-DW

PRODUCT NUMBER	L	W	D	∅	SH	BH	TH	LW	LM	K	LS	DIM	
2630-37-....-DW	78-145cm	100cm		10cm	3cm			26w	3120	2200/2700K		●	
2631-37-....-DW	78-145cm	130cm		10cm	3cm			34w	4080	2200/2700K		●	



2632-37-....-DW



PRODUCT NUMBER	L	W	D	∅	SH	BH	TH	LW	LM	K	LS	DIM	
2632-37-....-DW	78-145cm	170cm		10cm	3cm			42w	5040	2200/2700k			







“Light affects everything you see  
and how you see light is affected by everything”.

“When the night falls the desire for light is born.”

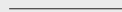

**master**light

# ADDITIONS

Materials | Spare parts | Accessories

# COLORS

INDUSTRIA | CONCEPTO | HOME



00

Concrete Coated



01

Bronze

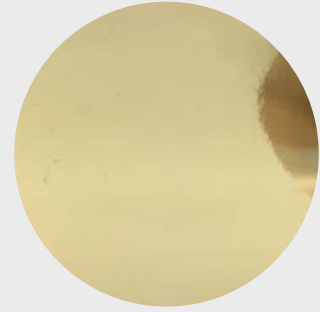

02

Brass Shiny



02

Brass Matt



05

Black Coated



06

White Coated



07

Chrome



08

Gold Leaf



08

Gold Coated



10

Antique Brass



25

Rust



30

Gun Metal

Each series has it's own color pallet

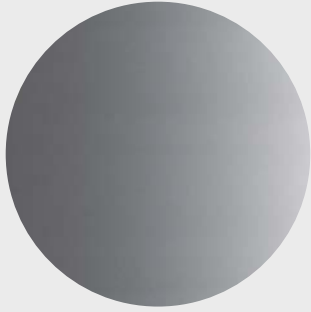

37

Silver Coated



37

Silver Leaf



37

Nickel Matt

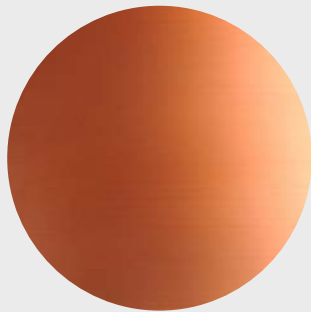

55

Copper Matt

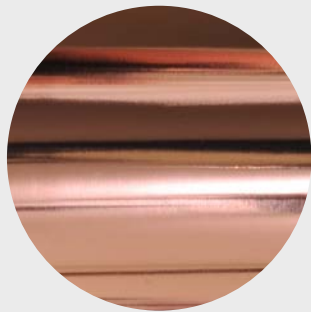

56

Copper Shiny



65

Aged Steel



66

Dappled Oil



70

Dappled Brown



81

Black Nickel



82

Black Chrome



# FABRIC COLORS



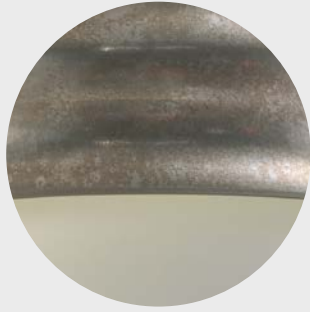

01

Dopler Gold



37

Dopler Silver

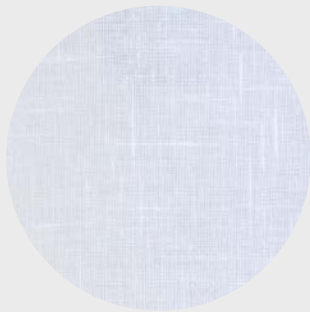

11

Camelot White

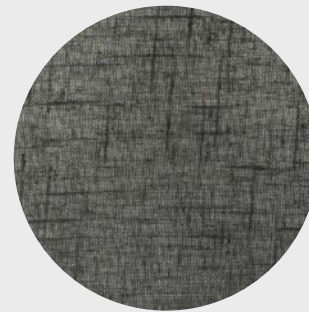

20

Camelot Black



82

Camelot Taupe

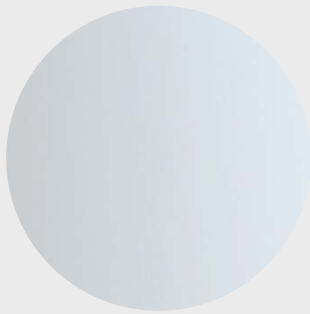

11

Chintz Off-White



20

Chintz Black

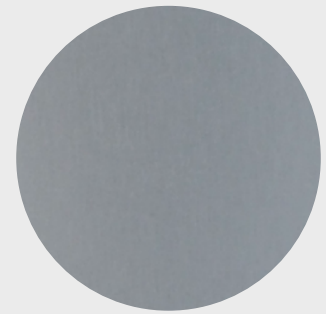

82

Chintz Grey

See the price list for all the available color combinations per series

# GLASS



See each individual serie in our price list - for all spare glasses and prices



# AVAILABLE GLASS COLORS



00

Pineapple Clear

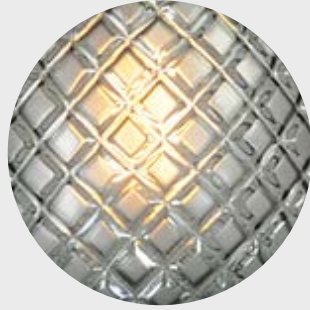

05

Pineapple Smoke



05GL

Lett Smooth



05

Lett Rib



51

Alabaster/White



14

Quinto Amber



05

Quinto Smoke



34

Alabaster/Amber



00

Bocca Clear



05

Bocca Smoke

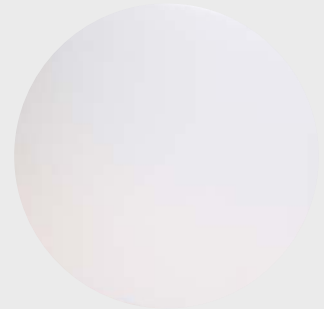

06

Matt White

# CEILING BASE





See our price list for all options and colors



# ACCESSORIES

Casambi | Bluetooth dimmer | Lightsources

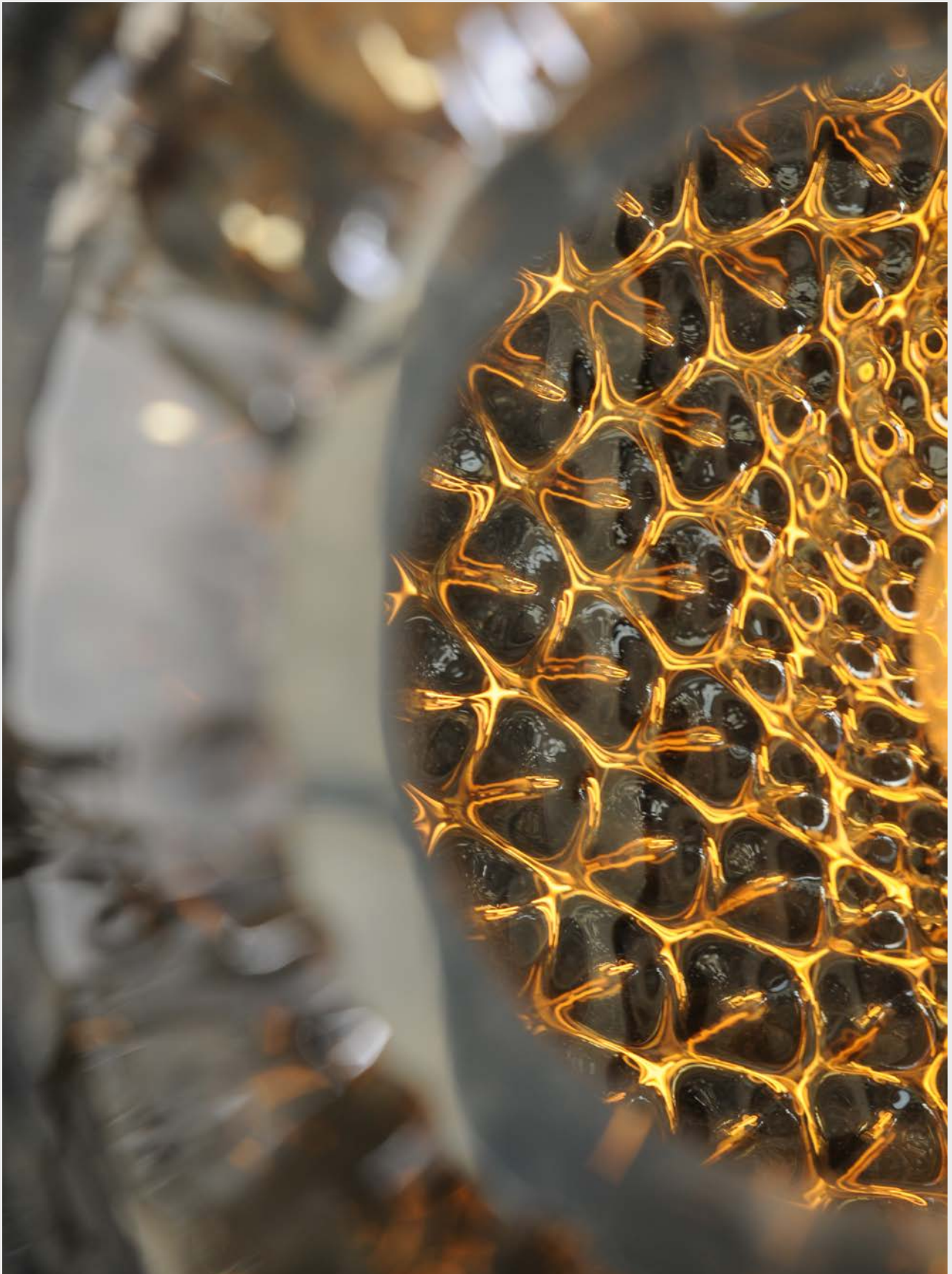

Fixture/Frame Color

- Color options available for this collection -

Shade Color



8-BLUE-TRIAC

## CASAMBI BLUETOOTH LIGHT CONTROL 230V DIMMER

- Easily operated Dimmer to control lamps with smartphone or tablet (Apple, Android) via Bluetooth
- For the operation of incandescent lamps, dimmable LED lamps and control gear for LEDs and halogen controlgear (not for magnetic transformers)
- Free App from CASAMBI (Apple / Android):
  - Lighting control (colour / dim level)
  - Configuration of luminaires and luminaires networks
  - Creation of scenes and animations (colour gradients)
  - Automatic detection of new devices
  - intelligent timer- and gallery functions
  - Protection settings of your luminaires network (only me, everybody, password access, ..)
- You can setup a Gateway, but it is not necessary
- Integrated antenna (Drawing grey marking, do not cover with metal case)
- In installation housing or with terminal cover
- Also controllable via mains switch or wall switch
- RWBT Xpress and RW...EBT
- Apple Watch compatible
- Max. 2 Lamps of the same type, max. 2 LED power supplies

PRODUCT NUMBER	L	W	D	∅	SH	BH	TH	MW	LS	DIM
8-BLUE-TRIAC		3.66 cm	4 cm			1.4 cm		50 w		●

# LED



SLF023981405



SLF023860609



SY0028002



SLF023981105



SLF023850309



SY0028009



SLF023981305



SLF023981205



SY0028006

PRODUCT NUMBER	L	W	D	∅	SH	BH	TH	LW	LM	K	LS	DIM
SLF023981105				16,5 cm	30 cm			4 w	250	2000k	E27	○
SLF023981205				20 cm	29 cm			4 w	250	2000k	E27	○
SLF023981305				18 cm	37 cm			4 w	250	2000k	E27	○
SLF023981405				12 cm	44 cm			4 w	250	2000k	E27	○
SLF023850309				3,5 cm	12 cm			4 w	250	2200k	E14	○
SLF023860609				6,4 cm	14,3 cm			6,5 w	470	2200k	E27	○
SY0028002				6,4 cm	14,3 cm			5 w	250	2000k	E27	○
SY0028009				12 cm				5 w	250	2000k	E27	○

# LIGHT SOURCES



SY0026648



SY0029962



SY0029003



SY0026683



SLF022352671



SY0029001



SY0026947

PRODUCT NUMBER	L	W	D	∅	SH	BH	TH	LW	LM	K	LS	DIM
SLF022352671				0,5 cm	1,6 cm			3,5 w	300	2700k	G9	○
SY0026947				4,5 cm				5,6 w	470	2700k	E27	○
SY0026683				7 cm				11 w	1060	2700k	E27	○
SY0026648				8 cm				16 w	1521	2700k	E27	○
SY0028006				9,5 cm				5 w	250	2000k	E27	○
SY0029001				14 cm	9 cm			8 w	806	2700k	E27	○
SY0029003				19,2 cm	11,8 cm			10,5 w	1000	2700k	E27	○
SY0029962				5 cm	5 cm			5 w	345	2700k	GU10	○

# PROJECTS

Since the foundation of the company in 1987, Masterlight has specialized in project lighting, building a wealth of knowledge, research and experience in the process. Combining this knowledge with the best steel processors, glass blowers and artisans at our disposal, it has achieved amazing results for our customers.

“REAL ADVICE MAKES THE DIFFERENCE”.

**master**light



# Van der Valk Hotel

| MASTERLIGHT PROJECTS |



In cooperation with Lichtstudio Ralph Blankenaauw BV - Masterlight Projects  
Van der Valk Hotel - Hertog Eduardplein 4, 6663 AN Nijmegen The Netherlands







# Van der Valk Hotel

| MASTERLIGHT PROJECTS |



In cooperation with Lichtstudio Ralph Blankenaauw BV - Masterlight Projects  
Van der Valk Hotel - Hertog Eduardplein 4, 6663 AN Nijmegen The Netherlands







# Mijn Modewereld

| MASTERLIGHT PROJECTS |



In cooperation with Lumenplan - Masterlight Projects

Modewereld / Brasserie 't Pakhuys de Wijk - Dorpsstraat 44, 7957 AW De Wijk, The Netherlands



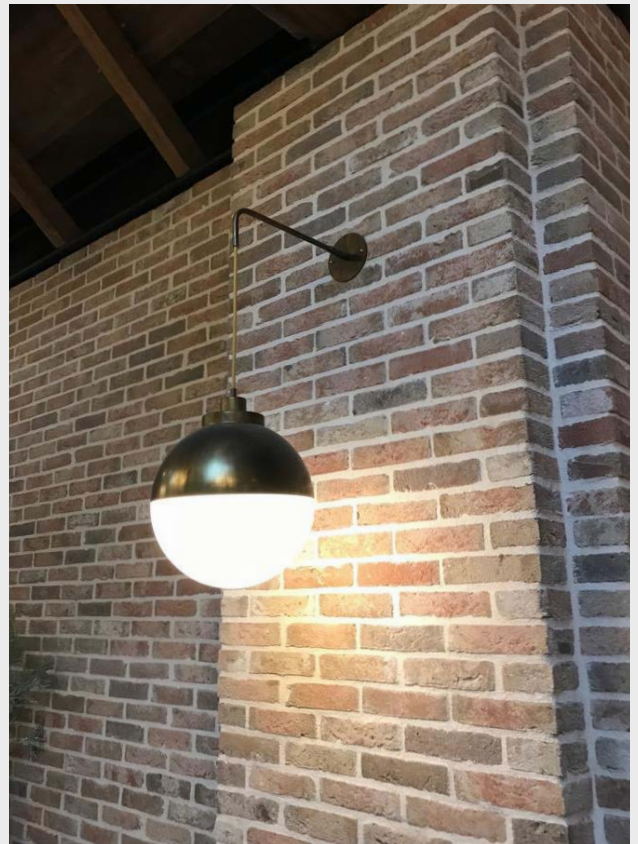
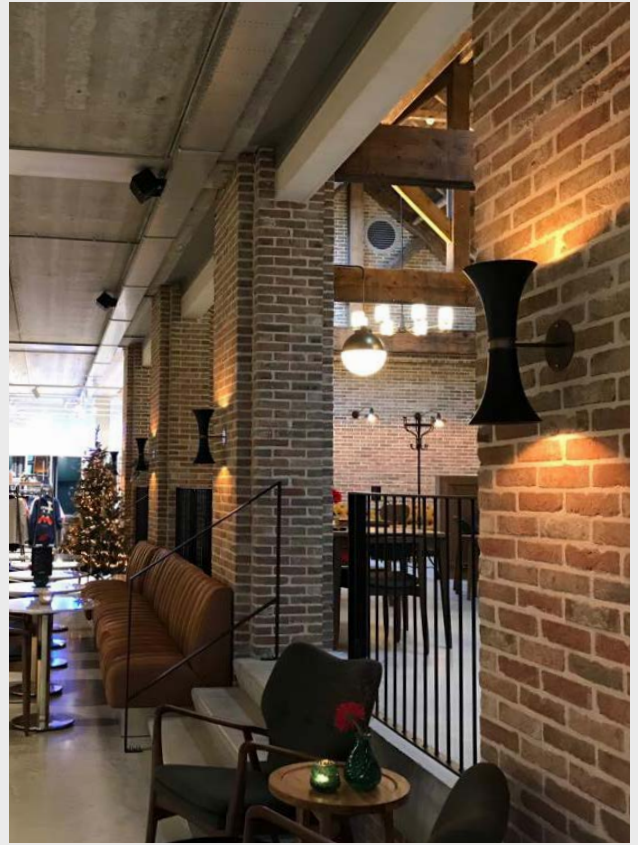



# Mijn Modewereld

| MASTERLIGHT PROJECTS |



In cooperation with - Masterlight Projects

Modewereld / Brasserie 't Pakhuys de Wijk - Dorpsstraat 44, 7957 AW De Wijk, The Netherlands



# Postplaza Hotel

| MASTERLIGHT PROJECTS |



In cooperation with Stars design - Masterlight Projects  
Postplaza Hotel - Tweebaksmarkt 27, 8911 KW Leeuwarden, The Netherlands



# BMW Brandstore

| MASTERLIGHT PROJECTS |



In cooperation with Van Lier Maatwerk - Masterlight Projects  
BMW Brandstore Brussels - Waterloolaan 23-24, 1000 Brussels Belgium





# City Hall Peel&Maas

| MASTERLIGHT PROJECTS |



In cooperation with De Twee Snoeken Architects - Masterlight Projects  
Gemeente Peel&Maas - Wilhelminaplein 1, 5981 CC Panningen The Netherlands



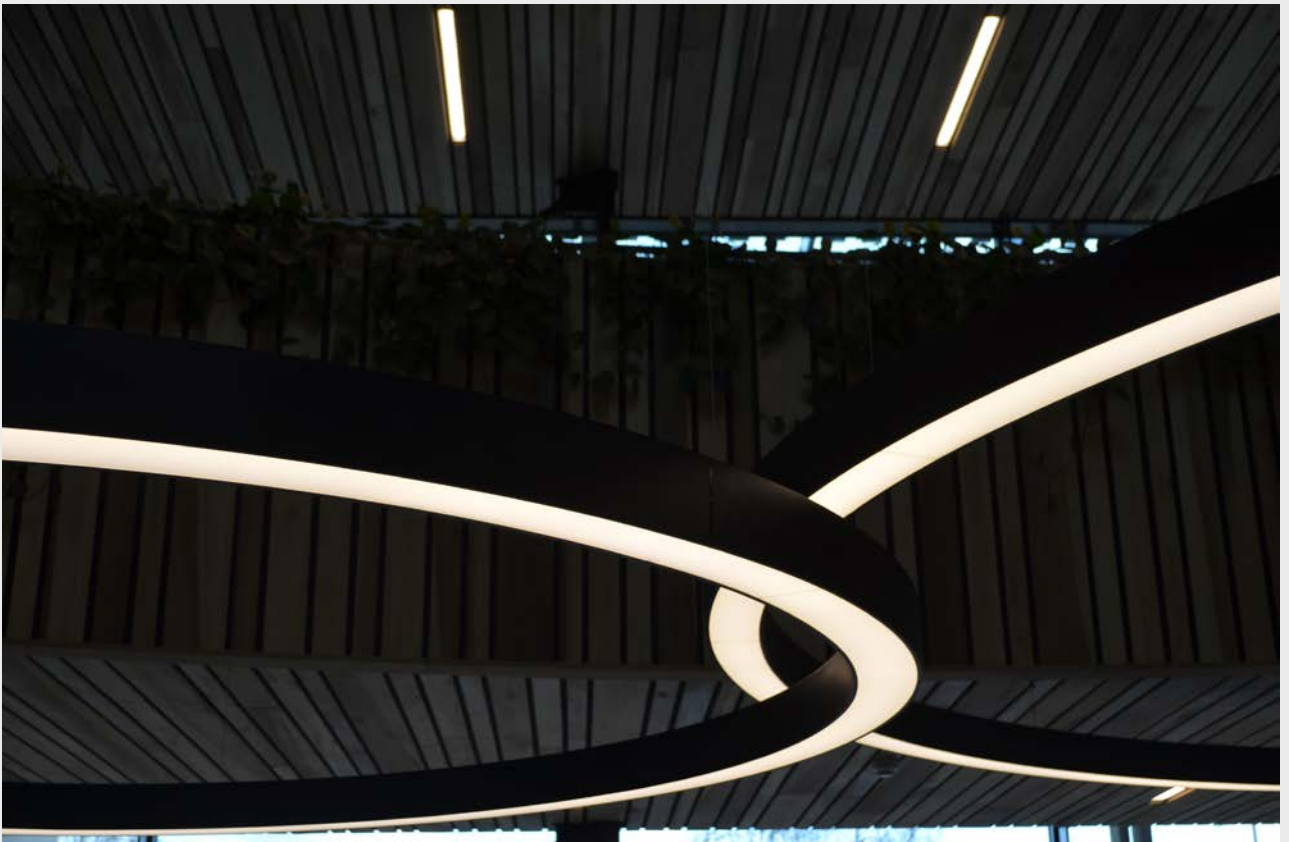
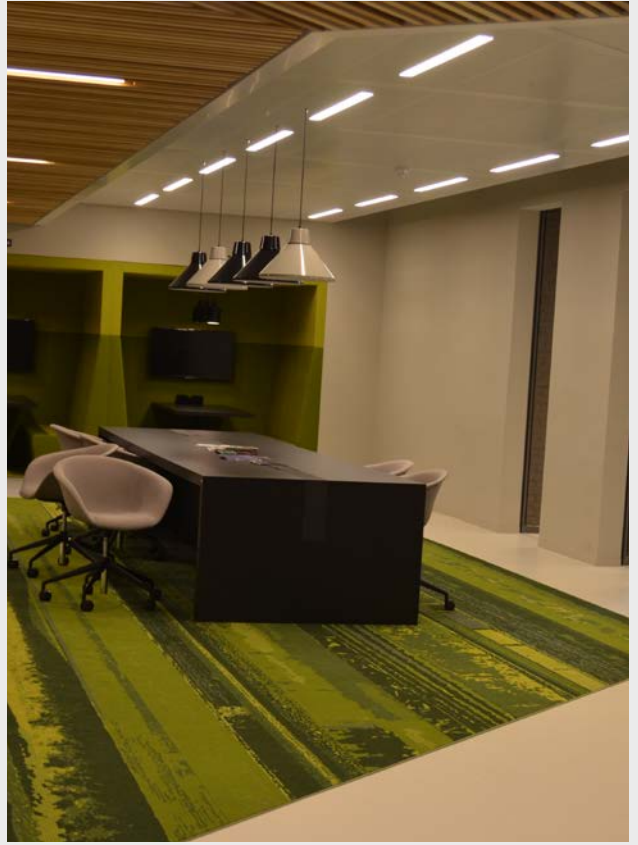

# Kanne Group

| MASTERLIGHT PROJECTS |



In cooperation with - Masterlight Projects  
Kanne Group - Industriestraße 10, 26906 Dersum, Germany





# Equestrian centre

| MASTERLIGHT PROJECTS |



In cooperation with Thomassen Interieurs - Masterlight Projects  
Equestrian centre de Peelberg - Travers 5, 5976 PL Kronenberg, The Netherlands







# Guesthouse Hotel

| MASTERLIGHT PROJECTS |



In cooperation with Vervoort Projecten - Masterlight Projects  
GuestHouse Hotel - Gasthuisstraat 118, 5171 GJ Kaatsheuvel, The Netherlands





# WP Haton

| MASTERLIGHT PROJECTS |

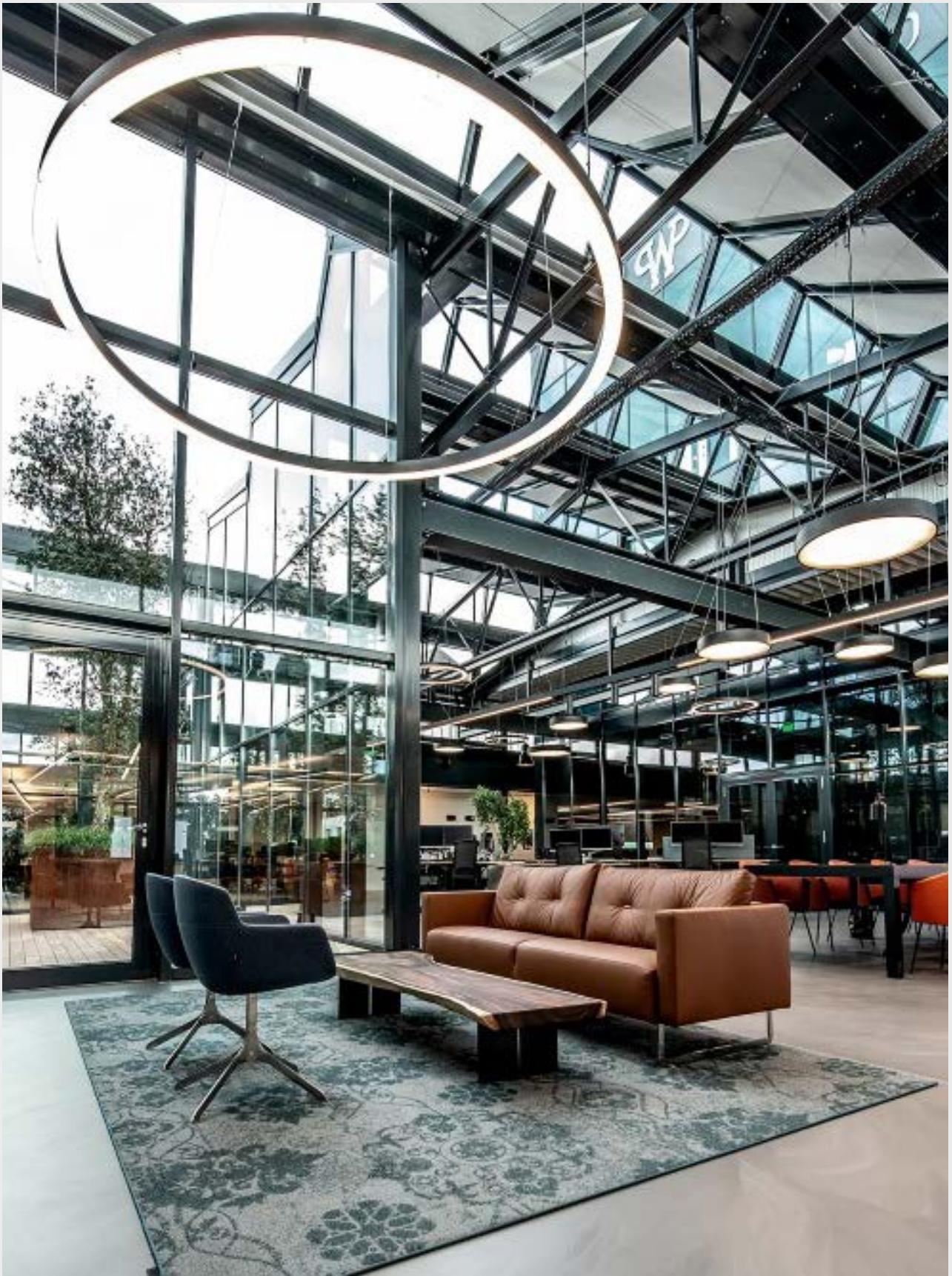

In cooperation with Hees Lights&Living - Masterlight Projects  
WP Haton - Industrieterrein 13, 5981 NK Panningen, The Netherlands





# Nieuwbeijerland Church

| MASTERLIGHT PROJECTS |



In cooperation with Maas en Hagoort - Masterlight Projects  
Gereformeerde Nieuw-Beijerland - Dorpsgaard 1, 3264 PG Nieuw-Beijerland, The Netherlands





# City Hall Haarlem

| MASTERLIGHT PROJECTS |



In cooperation with Maas en Hagoort - Masterlight Projects  
Gemeente Haarlem - Grote Markt Haarlem, The Netherlands





# Private Residence

| MASTERLIGHT PROJECTS |



Masterlight Projects - Private Residence  
Nederweert, The Netherlands

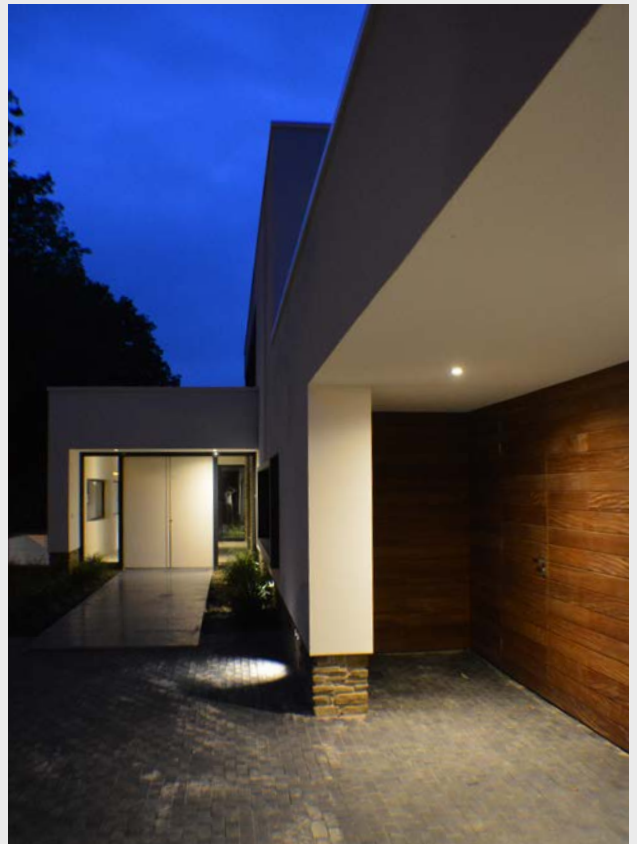
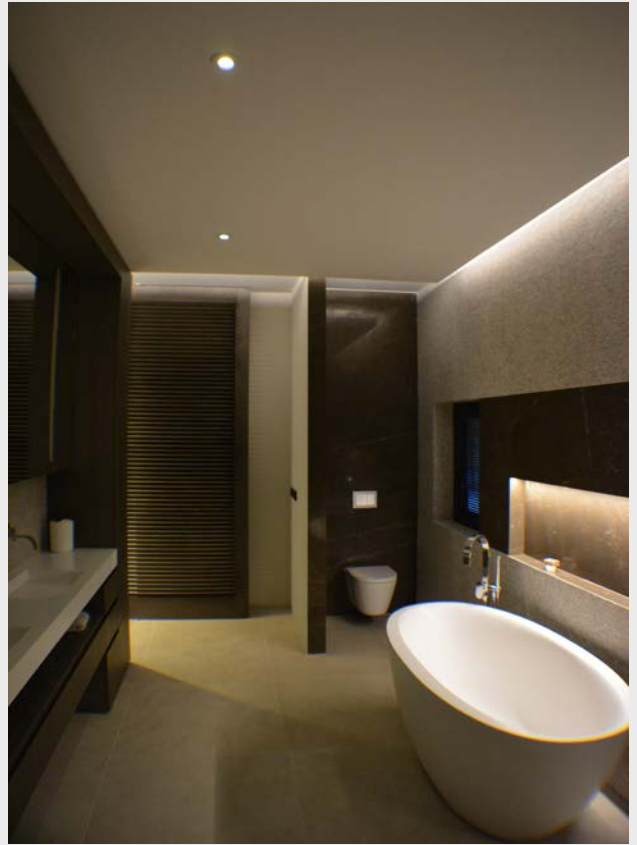



# GENERAL INFORMATION

MASTERLIGHT products are designed and manufactured in compliance with **CE** norms. Dimensions are indicated in centimeters. Supply voltage can be either 230V, 50Hz. Luminaires are normally supplied without light sources, except when otherwise indicated in the catalogue. Characteristics of the light sources are indicated in the specifications of each appliance. Products with anodized finishes could show different colour shades due to the industrial galvanic process. Shades have to be considered as aesthetic elements of the product. Polishing process is hand-made. Shades are therefore due to this manual process. Dimensions of products made with deformations of extrusions could be subject to changes of  $\pm 1$ cm. As blown glass is produced by traditional craft techniques, its thickness, colour and finishes are subject to variations, a feature that makes each piece unique. MASTERLIGHT reserves the right to make any technical or formal alterations to its products without giving prior notice, especially for LED sources.

WARRANTY conditions are 5 Years on the LED fixtures.

**masterlight**



# GENERAL TERMS

## Definitions

Art. 1.1.1. In these General Terms and Conditions the terms that are capitalised have the following meaning:

a. General Terms and Conditions: the provisions of this document. b. Claim "means any Claim of any kind (right), due to a breach, tort, unjust enrichment or otherwise. c. Communication to Other Party: all by Eurolight under a contract of sale, contract of assignment or other agreement provided Information, Documents or other related items, regardless of the form in which the supply takes place. This includes by Eurolight manufactured (concept) reports, memoranda and concepts. d.Consumer: a natural person not acting in the exercise of a profession or business e.Documents: the advice, recommendations,calculations, drawings,(light) plans, reports, designs, and such to be produced or issued by Eurolight and/or the Other Party. These Documents, including digital files, may be laid down in writing and on other data carriers, such as on CD-ROMs, DVDs, USB sticks and the like. f.Flaw: a demonstrable abnormality in an object or service in relation to the agreed properties. g.Information: information, data, Documents, materials and instructions or confidential information by Eurolight, the Other Party or third parties. h. Intellectual Property rights: all intellectual property rights and related rights, such as copyright law, trademark law, patent law, design law, trade name rights, database rights and related rights, as well as rights on know-how. i.Assignment: a by the Other Party provided or between the Parties agreed instruction to develop or produce (customised) business, consulting and maintenance. j. Agreement: the underlying agreement of purchase, adoption of work and/or Assignment. k.Party: each party to the Agreement. l.Damages: any and all Claims, damages and costs arising from or in any manner whatsoever related to the Agreement or the services. m.In writing: this includes by letter, by e-mail, by fax or any other means of communication that in view of the state of the art and according to commonly held public opinion is considered equivalent to these means of communications. n.Confidential information: all information, trade secrets or other proprietary information protected as confidential or which by its nature is confidential. o.Other Party: the buyer, customer or client. p. Products: lighting equipment and all associated materials, spare parts, accessories and the like, including stock articles from Eurolight as items that are manufactured in command, unless in a provision expressly is indicated that this provision will only see at the last category.

## Applicability general terms and conditions and Agreement

Article 2.2.1. These General Terms and Conditions apply to all offers and Agreements and all (legal) relationships between Eurolight and the Other Party, even if these (legal) relationships do not lead to, or are not related to an Agreement.The general Terms and Conditions therefore also apply to repeat-orders, part-orders, after-orders and part-Assignments derived from the Agreement. 2.2.These General terms and Conditions also apply to any use by the Other Party of the website of Eurolight. 2.3.Unless expressly agreed otherwise, the applicability of other general terms and conditions is excluded. 2.4.Due to the specific nature of a particular Agreement in that same Agreement can be exempted from one or more of the provisions of the General Terms and Conditions. 2.5.In the event Eurolight has commenced with the services (for example to collect Information, to plan a project or a first advice) the Agreement shall enter in effect and the Other Party shall reimburse these efforts, even if ultimately no Agreement is reached.

## Formation of the Agreement

Art. 3.3.1. Expressions of Eurolight on its website with regard to the availability of Products or services shall be construed as an invitation to make an offer. Each Agreement is entered into under the condition precedent of sufficient availability of the relevant Products or services. The Agreement comes into effect by the acceptance of the order by Eurolight Is the order placed via the website then the Agreement comes into effect by the confirmation of the order by Eurolight. Confirmation can take place electronically (for example, via the website, by email or by SMS or similar technologies) or, if this is agreed, in writing (by fax or letter). 3.2.Eurolight is only legally bound to an Assignment or an order without prior offer, oral agreements or additions or amendments to the General Terms and Conditions or Agreement upon written confirmation to the Other Party or as soon as Eurolight-without objection by the Other Party-has begun with the performance of the contract, purchase order or Assignment. 3.3.Parties are entitled to prove that the Agreement has come into effect in another way. 3.4.In the case of regular continuous business relations these General Terms and Conditions apply to all subsequent transactions and Assignments, even if not explicitly agreed upon.

## Offers and quotations

Art. 4.4.1. All quotations and offers made by Eurolight are not legally binding and may always be revoked by Eurolight, even if they contain a period for acceptance. Eurolight has the right to revoke an offer or quotation within two working days after acceptance of the offer or quotation by the Other Party. 4.2.In case of a composite offer or quotation Eurolight is not obliged to supply a part of the offered performance or Product against a corresponding part of the price 4.3.If the offer or quotation is based on Information provided by the Other Party and such Information proves to be incorrect or incomplete or the Information changes afterwards, Eurolight is entitled to adjust the specified prices and/or delivery times. 4.4.The offer, quotation and/or prices do not automatically apply to repeat orders or follow-up contracts. 4.5.Shown and/or provided models and examples as well as presentations, versions, assignments of colours, materials, sizes, types, lumens and other descriptions in brochures, promotional material and/or on the website of Eurolight are as accurate as possible, but apply only to denote. The Other Party can derive no rights here. 4.6.De models and examples provided remain the property of Eurolight and must be returned at first request and on the expense of the Other Party to Eurolight. 4.7.Eurolight is entitled to charge the Other Party for the costs linked to an offer, provided that Eurolight in advance and in writing has pointed out these costs to the Other Party. 4.8.If the Other Party does not accept an offer or quotation, the Other Party must at the first request of Eurolight return all the Documents delivered with this offer or quotation to Eurolight.

## Prices and payment

Article 5.5.1 The Other Party shall pay the price specified in the Agreement for the Products or services. Payment takes place on the manner indicated by Eurolight. 5.2.The prices mentioned in an offer, quote or price list are exclusive of VAT and any other costs, such as government levies, transportation costs, assembly costs, administrative expenses and declarations of third parties 5.3.If, between the date of the conclusion of the Agreement and its performance (cost) price raising circumstances occur due to changes in the law and regulations, government measures, currency fluctuations or changes in the prices of the needed materials, spare parts, accessories and such, Eurolight is entitled to increase the agreed prices accordingly and charge the adjusted prices to the Other Party. 5.4.Eurolight is entitled to change the prices mentioned on the website and the published rates in advertisements without notice. 5.5.In case of payment against invoice the Other Party must pay within 30 (thirty) days after receipt of the invoice, unless different terms of payment are indicated by Eurolight. Invoices sent by mail shall be deemed to have been received within 2 (two) days after postmarked in the Benelux and within 5 (five) days after post stamp in other countries, unless the contrary is proven by the Other Party. The accuracy of an invoice shall be certain if the Other Party not objects within this fixed payment term. The Other Party is entitled to prove the contrary. 5.6.In case of late payment, Eurolight has the right to: 1) without any given notice or communication required, charge the statutory interest rate or to charge commercial interest on the entire amount due from the date on which payment should have taken place until the date the amount is received by Eurolight; and 2) after given notice to transfer the Claim for collection to a third party.The Other Party shall reimburse all costs that Eurolight and this third party have to make to collect the amount due, including, inter alia, costs of legal assistance, legal costs and extrajudicial costs, the latter with a minimum of 15 (fifteen)% of the outstanding sum, with a minimum of €150. A formal notice can be sent electronically if the Other Party has chosen electronic payment or when payment took place after the receipt of an electronic invoice. 5.7.Eurolight is entitled to (partial) advance payment or any other form of security for payment of the Other Party. 5.8.If an invoice is not fully paid after the deadline referred to in article 5.5 of these General Terms and Conditions or no automatic direct debit has taken place, the Other Party is due a late fee chargeable for the size of 2% per month, cumulative to be calculated on the principal amount, unabated the other rights of Eurolight. Parts of a month shall be counted as a full month. 5.9.In the absence of full payment by the Other Party Eurolight is entitled to terminate the Agreement by a written declaration or to suspend its obligations under the Agreement until the Other Party pays the amount due or provides satisfactory security. Eurolight is entitled to execute this right of suspension before the Other Party is in default with the payment and has legitimate grounds to doubt the creditworthiness of the Other Party. 5.10. Payments made by the Other Party will be first deducted from all interest and costs due and then will be deducted from the due and payable invoices which have been open longest, unless the Other Party states in writing that the payment relates to a later invoice. 5.11.The Other Party is not entitled to set off any Claims of Eurolight against counterclaims that the Other Party has against Eurolight. This also applies if the Other Party (provisional) has applied for a suspension of payments or is declared bankrupt. 5.12.If the Other Party is a Consumer Eurolight is entitled to demand (partial) prepayment or any security for payment from the Consumer. 5.13.Is the Other Party a Consumer then the requested prepayment shall not exceed 50% of the agreed price. Payment must be made within an expiry period of 8 (eight) days following the invoice date, unless the Parties have agreed another payment period in writing. The correctness of an invoice will be assumed, if the Consumer has not objected within this payment period. The Consumer is entitled to prove the contrary. 5.14.If following expiry of the period as mentioned in the previous paragraph an invoice has not been fully paid or no automatic direct debit has been possible, the Consumer owes Eurolight delay interest in the amount of 2% per month, to be calculated cumulatively on the principal amount. Parts of a month will be considered a full month.

5.15.If following reminder by Eurolight payment is still not made, Eurolight is entitled to charge extra judicial collection costs to the Consumer. Eurolight will in its reminder as referred to above grant the Consumer a further period of at least 14 (fourteen) days to make the payment. 5.16.The extra judicial collection costs as referred to in the previous paragraph of this article 5 amount to: a.15% of the total principal amount for the first € 2,500 of the Claim (with a minimum of € 40); b.10% of the total principal amount for the next € 2,500 of the Claim; c.5% of the total principal amount for the next € 5,000 of the Claim; d.1% of the total principal amount for the next € 190,000 of the Claim; e.0,5% of any further principal amount. All these amounts with an absolute maximum of € 6,775. 5.17.For the calculation of the extra judicial collection costs, after expiry of 1 (one) year, Eurolight is entitled to raise the principal amount of the Claim by the total cumulative delay interest in that year, in accordance with paragraph 3 of this article. 5.18.If the Consumer continues to fail to make full payment Eurolight is entitled to terminate the Agreement without further notice of default by issuing written notice, or to suspend its obligations arising from the Agreement, until the Consumer has paid or has issued sound security for the amount due. This right to suspend the performance of the Agreement also accrues to Eurolight if, even before the Consumer is in default of making payment, Eurolight has sound reason to doubt the creditworthiness of the Consumer. 5.19.Payments made by the Consumer will first be deducted by Eurolight from all interest and costs payable, and subsequently from the only outstanding demandable invoices, unless the Consumer states in writing that the payment relates to a later invoice.

# AND CONDITIONS

## Delivery and delivery terms

Art. 6.6.1. Delivery deadlines are never fatal. If Eurolight fails to meet its obligations or fulfils its delivery obligations to late, the Other Party shall declare Eurolight in default by written notice and shall set Eurolight a reasonable term to meet its obligations. 6.2. Eurolight is entitled to delivery in parts or to carry out of the Assignment in parts. Each part of the delivery or the Assignment can be invoiced separately. 6.3. The risk for the Products is transferred to the Other Party at the moment Eurolight makes the Products available to the Other Party. This is the moment when the Products leave the works. 6.4. Shipment or transport of the Products takes place at the expense and risk of the Other Party and in a manner determined by Eurolight. Eurolight is not liable for Damages or losses that are related to the shipment or transport. 6.5. Should delivery of the Products (in the agreed manner) prove impossible, due to a cause in the risk of the Other Party, Eurolight is entitled to store and safeguard the Products at the expense and risk of the Other Party. The Other Party is obliged to enable Eurolight (within a reasonable period set by Eurolight after notification of the storage) to deliver the Products. 6.6. If the Other Party after the period referred to in the preceding paragraph fails to comply with his obligation, he is immediately in default. Eurolight is then entitled to fully or partially terminate (rescind) the Agreement with immediate effect by written statement. Eurolight shall be entitled to sell the Products to a third party without an obligation for compensation for Damages, costs and interests. The above shall not affect the obligation of the Other Party for compensation for any costs, like (storage), delay damages, lost profits or other Damages or the right of Eurolight to still claim performance of the Agreement.

## Progress and performance of the Agreement

Article 7.7.1. If the agreed delivery of Products is delayed because: a. Eurolight has not received on time all the necessary Information and/or materials from the Other Party; b. Eurolight has not received on time any agreed (forward) payment of the Other Party; c. There are other circumstances considered to be for the account and risk of the Other Party; Eurolight shall be entitled to a reasonable extension of the delivery period and to compensation of the related costs and Damages. 7.2. If the Assignment is carried out in phases, Eurolight shall be entitled to suspend the performance of the parts of the Assignment belonging to a following phase, until the Other Party has approved the results of the previous phase. The resulting costs and Damages shall be for the account of the Other Party. 7.3. Eurolight is bound to point out imperfections, errors, defects and such in the by or on behalf of the Other Party: a. provided Documents; b. instructions; c. provided or prescribed materials;

as far as these imperfections, errors, defects and the like are relevant to the performance of Eurolight and are known to Eurolight. 7.4. If the Other Party wants changes in the agreed Assignment and/or deliveries, Eurolight will inform the Other Party about the consequences that these changes have for the agreed prices and delivery times. 7.5. Should an occurrence of events which could not have been reasonably foreseen prevent the agreed performance of the Agreement Eurolight will consult with the Other Party about amendment of the Agreement. Eurolight will inform the Other Party on the implications of the modifications of the Agreement for the agreed prices and delivery times. If the performance of the Agreement has become impossible as a result of these unforeseen circumstances, Eurolight has right to full reimbursement of the costs incurred. 7.6. The Other Party shall carefully check every draft version of the Documents made by Eurolight and as soon as possible communicate his reaction to Eurolight. If necessary, Eurolight will adapt the concept and once again communicate to the Other Party for approval. Eurolight is entitled to request that the final version of the Documents shall be initialled per page for approval by the Other Party or that the Other Party signs a written letter of approval of the final version. 7.7. If the Parties have agreed that Eurolight will submit test models of the Products to be manufactured for approval to the Other Party, the Other Party shall carefully review these experimental models and as soon as possible communicate a reaction to Eurolight. Eurolight can require that the Other Party shall sign a written statement of approval regarding the final version of a test model. 7.8. In the event Eurolight is bound to make changes or adaptations in already approved Documents or test models, this will be considered as additional work and Eurolight shall be entitled to charge the resulting additional costs to the Other Party.

## Additional work

Article 8.8.1. Additional work needs to be agreed between the Parties in writing. Eurolight is only bound to oral agreements after confirmation in writing to the Other Party or in the event Eurolight -without objection by the Other Party- has started with the performance of the additional work. 8.2. Setting off additional work takes place: a. in the event of any changes in the original Agreement; b. in the event of unforeseen cost increases or reductions and abnormalities of deductible in the estimated quantities. 8.3. Setting off additional work takes place directly at the final settlement of the Agreement, unless the Parties have agreed otherwise in writing.

## Delivery and approval of Assignments

Article 9.9.1. With respect to the developed or manufactured Products by Eurolight, Eurolight is bound to communicate to the Other Party that the Assignment has been completed and the Products are ready for use. 9.2. The Products shall be deemed to be delivered in accordance with the Agreement, if they are made available to the Other Party, and the Other Party -as far as possible- has checked the operation of these Products and the agreed specifications, attributes, qualities and such and if the consignment note or accompanying note is signed by the Other Party. 9.3. The Products are also deemed to be delivered in accordance with the Agreement if the Other Party has not objected within a period of two (2) weeks after the Products made available or earlier in the event the Other Party had the Products -as far as possible- before this day already in use. 9.4. Work not yet undertaken or not yet completed by third parties called in by or on behalf of the Other Party which affects an appropriate use of the Products, do not effect the delivery of the Products and the availability for use of the Products. 9.5. If following delivery by Eurolight the Other Party still wishes to have changes made to the Product, this shall be classified as extra work. Eurolight shall be entitled to charge the resulting costs separately at the Other Party.

9.6. If following delivery by Eurolight as intended in this article 9 of these General Terms and Conditions the Other Party still observes defects, imperfections etc. relating to the Product, the provisions contained in article 11 of these General terms and Conditions concerning complaints shall apply.

## Packaging

Art. 10.10.1. Eurolight is not obliged to take back packaging. Eurolight is entitled to leave packaging at the Other Party's premises. Any costs for removal of the packaging are to be borne by the Other Party.

## Complaints and returns

Art. 11.11.1. The Other Party is obliged to check the delivered Products immediately upon receipt and to state any visible defects, deficiencies, damage, deviations in numbers and/or other non-conformities on the accompanying note or consignment note. In the absence of an accompanying note or consignment note, the Other Party is obliged to report the deficiencies, defects and the like within 8 (eight) days after receipt of the Products to Eurolight stating the details, followed by a written confirmation. 11.2. In the absence of a notification as referred to in the preceding paragraph, the Products shall be deemed received in good condition and in accordance with the Agreement. 11.3. Other complaints about the delivered Products must be reported to Eurolight in writing, immediately after discovery - but at the latest within the warranty period. The Other Party shall bear all expenses and risks of failing to report directly. 11.4. If a complaint is not reported to Eurolight within the period stated in the previous articles, no appeal shall be possible subject to any agreed warranty. 11.5. The ordered Products can be delivered in the wholesale packaging that Eurolight has in stock and in minimum amounts or quantities. Minor deviations in respect of the given numbers, dimensions, weights, quantities and colours that are acceptable in the branch as minor shall not constitute as a shortcoming on the part of Eurolight. No complaints shall be permitted with regard to these small deviations. 11.6. In the event of a complaint the Other Party is not entitled to suspend its payment obligation. 11.7. The Other Party is obliged to enable Eurolight to investigate the complaint and to provide Eurolight with all the relevant Information. If in order to investigate a complaint Products need to be returned, this shall take place for account and risk of the Other Party, unless the complaint turns out to be justified. The risk of the transport risk shall always be borne by the Other Party. 11.8. In all cases, return shipment shall take place in a manner stipulated by Eurolight, and in the original packaging or wrapping. 11.9. No complaints shall be possible regarding incompleteness or properties of items manufactured from natural materials, if these imperfections or characteristics are inherent to the nature of these materials. 11.10. No complaints are possible about discoloration and slight discrepancies in colours. 11.11. No complaints shall be possible regarding items, which following receipt by the Other Party have changed with respect to their nature and/or composition, have been completely or partly worked or processed.

## Guarantees (Warranties)

Art. 12.12.1. Eurolight ensures that the agreed Assignments and deliveries are carried out correctly and in accordance with the standards applying in the branch. Eurolight will do everything commercially reasonable to render the performance agreed upon. Eurolight shall never give a more extensive guarantee for Products delivered than as expressly agreed between the Parties. 12.2. Eurolight is responsible during the guarantee term for the usual normal quality and reliability of the delivered Products. If no explicit warranty term is agreed a term of 1 (one) year after delivery shall be in force. 12.3. When using (raw) materials necessary for the performance of the Agreement Eurolight relies on the Information provided by the manufacturer or supplier of these (raw) materials. If the supplier or manufacturer of the Products delivered by Eurolight has given a guarantee, this guarantee shall apply back to back in the same manner between the Parties as a guarantee issued by Eurolight. Eurolight informs the Other Party accordingly. 12.4. If the purpose for which the Other Party wishes to use the Products is different from the standard use of these Products, Eurolight will only guarantee that the Products are suitable for this purpose if Eurolight has duly issued a written confirmation to the Other Party.

12.5. No Claim under any guarantee is possible, as long as the Other Party not has yet paid the agreed price or payment for the Products or the Assignment. 12.6. In the event of a legitimate Claim under the guarantee - at its own discretion - free of charge, Eurolight will undertake to repair or replace the Products, or to manufacture the Products again or to make a repayment or give a discount on the agreed price. If there are any additional Damages these shall be subjected to article 13 "Liability" of these General Terms and Conditions. If the Other Party is a Consumer this article 12.6 does not apply. 12.7. In the event of a breach of the guarantee Eurolight is still entitled to invoke force majeure. 12.8. After the guarantee period has expired the Other Party is no longer entitled to claim breaches or shortcomings in the Products or services delivered.

# GENERAL TERMS

## Liability

Art. 13.13.1. Eurolight shall accept no liability other than the guarantees explicitly agreed or given by Eurolight for damages, on any account whatsoever. 13.2. Without prejudice to the provisions of the previous paragraph of this article of these General Terms and Conditions Eurolight shall only be liable for direct Damages or losses. Any liability of Eurolight for consequential Damages, such as business losses, loss of profits, and/or losses suffered, losses due to delay in delivery and/or physical or personal injury is expressly excluded. 13.3. The Other Party must take all measures necessary to prevent or limit any Damages or losses. 13.4. If Eurolight is liable for Damages or losses suffered by the Other Party, Eurolight's obligation to compensate Damages or losses is restricted to the maximum amount paid by its insurer(s). If the insurer does not pay or the Damages or losses are not covered by insurance taken out by Eurolight, the obligation to compensate is restricted to the amount of the invoice for the delivered Products or services rendered, with a maximum of € ..... per year. 13.5. The Other Party is obliged to duly claim for the Damages or losses no later than 6 (six) months after he has become aware with or might have become aware with the Damages or losses suffered. Is the Other Party a Consumer then the term to claim is one year. 13.6. If Eurolight is required to carry out the Agreement on the basis of Documents provided by or on behalf of the Other Party, Eurolight is not responsible for the content, accuracy and completeness of these Documents. 13.7. If the Other Party makes materials available for processing Eurolight will be responsible for correct processing, but shall not be responsible nor for the soundness of these materials nor for the impact these materials have on the final result. 13.8. Eurolight shall not be held liable and the Other Party can not claim under a guarantee if the Damages or losses have occurred due to: a. by improper use or use contrary to the intended purpose of the Products delivered or to the instructions, manuals, opinions, instructions for use etcetera issued by or on behalf of Eurolight; b. by improper keeping (storage) or maintenance of the Products; c. due to overheating as a result of the use of lamps with too high a wattage; d. by external causes as lightning, lightning induction, flooding, storm damage etcetera; e. by environmental conditions, such as too high a humidity; f. by errors, omissions or defects in the by or on behalf of the Other Party to Eurolight provided or prescribed information or materials; g. by directions or instructions from or on behalf of the Other Party; h. because repairs or other work or processes carried out on the Products delivered by or on behalf of the Other Party or are delivered to the operations carried out, without the express prior permission of Eurolight. 13.9. In the cases listed in the previous paragraph of this article the Other Party shall be fully liable for all resulting Damages and losses and shall indemnify Eurolight expressly from all Claims from third parties for compensation of such damages and losses.. 13.10. The limitations and exclusions of liability included in this article 13 of these General Terms and Conditions do not apply if the Damages and losses are the result of wilful intent and or gross negligence of Eurolight or the managerial staff on Board level or when compulsory legal provisions are opposed. 13.11. The limitations and exclusions of liability included in this article 13 of these General Terms and Conditions do apply if a guarantee is breached or violated.

## Retention of title

Art. 14.14.1. Eurolight retains ownership of all Products delivered and still to be delivered according to the Agreement until the moment at which the Other Party has fulfilled all his payment obligations to Eurolight. 14.2. The payment obligations as referred to in the previous paragraph of this article 14 include paying the purchase price for the Products and Assignments, plus Claims for work performed in connection with the delivery and Claims due to culpable shortcomings by the Other Party in the performance of its obligations, such as Claims for the payment of compensation, extra-judicial collection costs, interest and possible penalties. 14.3. If this refers to the delivery of identical, non-individualised Products the consignment of Products relating to the oldest invoice shall be considered to be sold first. Retention of title always applies to all delivered Products which at the moment of claiming retention of title are still held in the Other Party's stock, store and/or inventory. 14.4. Products subject to retention of title may be sold on and delivered by the Other Party in the context of the normal course of the company's business activities, under the condition that the Other Party shall stipulate retention of title to its business customers on the Products delivered. 14.5. The Other Party is not authorised to pledge, mortgage, lease, transfer, hire or otherwise encumber the Products subject to retention of title, or place the Products under the (effective) control of a third party, like a financier, by means of so called pledging lists. 14.6. The Other Party is obliged to immediately inform Eurolight in writing if third parties pretend or claim to have rights in respect to the Products subject to title of retention. 14.7. The Other Party is obliged to keep the Products delivered under retention of title with appropriate care and recognizable as property of Eurolight. 14.8. The Other Party is obliged to take out contents or business insurance in order that the Products subject to retention of title are insured at all times. The Other Party is obliged to make the insurance policy and the respective premium payments available for inspection by Eurolight on first demand. 14.9. If the Other Party is acting in violation of the provisions included in this article 14 of these General Terms and Conditions or Eurolight invokes the retention of title, Eurolight and its employees and/or representatives shall have the irrevocable right, to enter the premises of the Other Party and to take back the Products delivered under retention of title. This shall apply without prejudice to the right of Eurolight to demand compensation of Damages and losses, loss of profit and interest and the right to terminate the Agreement without further notice of default by issuing written notice.

## Intellectual Property Rights

Art. 15.15.1. The Intellectual Property rights of all Products, goods or services that Eurolight supplies in the framework of the Agreement will remain with Eurolight or the third party from whom Eurolight has obtained the right (a part) to make these Products, goods or services available to the Other Party. With respect to software and other eligible Products, goods or services Eurolight hereby, subject to the condition precedent of payment by the Other Party of all the amounts owed in the context of the Agreement by him, grants a license to the Other Party that is non-exclusive and non-transferable, unless the Agreement explicitly provides otherwise.

The exercising of these rights is reserved expressly and exclusively to Eurolight both during and following completion of the performance of the Agreement.

15.2. This means inter alia:

1. That the Other Party is not allowed to use the delivered or produced Documents by Eurolight outside the context of the Agreement, he is not allowed to issue the Documents to a third party, he is not allowed to give third parties access to the Documents and he is not allowed to multiply these Documents without prior given written permission by Eurolight. 2. That the Other Party is not allowed to copy, alter, reproduce et cetera, the Products delivered by Eurolight or parts thereof, without prior written permission by Eurolight. 15.3. The Other Party guarantees that any of the Documents and files issued by him to Eurolight do not infringe copyrights or other Intellectual Property rights of third parties. The Other Party is liable for Damages or losses suffered by Eurolight as a result of such infringement and shall indemnify Eurolight against Claims from any such third parties.

## Force majeure

Art. 16.1.16.1. A Party is not obliged to fulfil one or more obligations other than obligations relating to the payment of money, if it is prevented from doing so as a result of force majeure. Force majeure includes a non-accountable shortcoming by third parties or subcontractors, and any situation beyond the reasonable control of the Party involved. 16.2. As soon as it is clear that the situation of force majeure endures for longer than 3 (three) months, Parties shall have the right to terminate the Agreement without being liable for Damages or losses. 16.3. If the force majeure situation occurs if the Agreement is carried out in part, the Other Party shall be obliged to fulfil his obligations towards Eurolight up to that time.

## Obligations of the Other Party

Art. 17.17.1. The Other Party must ensure that: a. All Information necessary for the performance of the Agreement is made available to Eurolight in good time in the form required by Eurolight; b. The Other Party shall inform Eurolight in good time about developments that are going on within his organization and that are or can be relevant for the performance of the Agreement; c. That the information carriers, electronic files, software et cetera provided to Eurolight by the Other Party are free of viruses and/or defects; d. The Other Party shall deliver all materials and Documents, of which the parties have agreed upon that the Other Party will provide, to Eurolight in good time and in good condition;. 17.2. The Other Party shall ensure that the Information provided is complete and correct and shall indemnify Eurolight for Claims by third parties arising from the incorrect and/or incomplete nature of this Information. 17.3. Eurolight will treat the Information provided by the Other Party as confidential and shall only provide the Information to third parties to the extent necessary for the performance of the Agreement. Eurolight will carefully save all of the Information and files received during the term of the Agreement. Eurolight shall never be liable for loss or destruction of this Information or files, unless this is due to intentional misconduct and/or wilful recklessness of Eurolight or the supervisory staff at a management level. The Other Party must always ensure that he retains the original or a copy of the Documents and files provided to Eurolight. 17.4. If the Other Party does not or not timely comply to aforementioned obligations Eurolight has the right to suspend the performance of the Agreement until the moment that the Other Party has fulfilled its obligations. The costs associated with the delay and the other consequences that result there from are for the account and risk of the Other Party. 17.5. If the Other Party fails to fulfil its obligations and Eurolight is in default to demand fulfilment from the Other Party, this shall not influence the right of Eurolight to demand compliance at a later date.

## Insourcing of third parties

Art. 18.18.1. If Eurolight believes that it is necessary for the correct performance of the Agreement, Eurolight may have work carried out by third parties for specific deliveries.

## Bankruptcy, absence of power of disposition et cetera

Art. 19.19.1. Eurolight is always entitled to terminate the Agreement without further notice of default, by issuing a written notice to the Other Party, at the moment at which the Other Party: a. is declared bankrupt or an application for his bankruptcy is issued; b. applies for a (temporary) moratorium; c. is placed under attachment under a warrant of execution; d. is placed under guardianship or administration; e. otherwise loses power of disposition or power of action in respect of its assets or part thereof. 19.2. The Other Party must always inform the guardian or receiver of the (content of the) Agreement and present General Terms and Conditions.



# AND CONDITIONS

## Termination, and suspension

Art.20.20.1.Parties are only entitled to terminate the Agreement in case of a substantial shortcoming in the performance of the Agreement. 20.2.If the Other Party wishes to cancel prior to or during performance of the Agreement, the Other Party shall pay compensation to Eurolight. Eurolight will determine the total amount of the compensation.The compensation shall be made of all costs incurred by Eurolight and of all losses suffered by Eurolight due to the cancellation, including loss of profit. Eurolight is entitled to fix the compensation and- at its discretion and depending on the deliveries already made- to charge between 20 and 100% of the agreed price. This right of cancellation does not exclude other rights and/or remedies from Eurolight. 20.3.In respect of third parties, the Other Party is liable for all the consequences of the cancellation and shall indemnify Eurolight against all resultant Claims made by these third parties. 20.4.Eurolight is entitled to set off all amounts paid by the Other Party against the compensation payable by the Other Party. 20.5.In the event of suspension of the performance of the Agreement at the request of the Other Party, all costs incurred at that moment shall be immediately demandable and Eurolight is entitled to charge these costs to the Other Party. Eurolight is also entitled to charge the Other Party of all costs incurred or to be incurred during the period of suspension. 20.6.If the performance of the Agreement can not be resumed following the agreed period of suspension Eurolight shall be entitled to terminate the Agreement by means of a written notice. If the performance of the Agreement is resumed following the agreed period of suspension the Other Party must pay any costs arising from this resumption to Eurolight.

## Impending delays

Art.21.21.1.In the event of impending delay of deliveries Eurolight shall inform the Other Party immediately in writing, stating the cause of the delay and its consequences. Eurolight will suggest measures to prevent further delay. 21.2.As soon as possible after receiving the notification referred to in the previous paragraph of this article, the Other Party shall notify Eurolight whether it agrees to the suggested measures. Acceptance does not mean that the Other Party recognises the cause of the impending delay and will not affect any rights or Claims that the Other Party is entitled to pursuant under the Agreement.

## Assignment of rights and obligations

Art.22.22.1.Assignment, selling or encumbering of Claims (in relation to the consequences in the property law) the Other Party has against Eurolight is explicitly excluded. 22.2.Eurolight is entitled to assign, sell or encumber its Claims against the Other Party to a third party.

## Loss of rights

Art.23.23.1.All Claims the Other Party has against Eurolight, arising from shortcoming in the performance of the Agreement, negligence or any other legal basis, will lapse as soon as a period of 1 (one) year has expired after the day the Claim became known to the Other Party or reasonably could have been known to the Other Party, and the Other Party not within that period of 1(one) year has brought the Claim before a court.

## Time and place of the performance of the Agreement

Art.24.24.1.The activities are carried out in accordance with the conditions about time and place set out in the Agreement. Unless otherwise agreed, the Other Party is entitled to change the place of the activities, provided that he notifies Eurolight no later than 5 (five) working days before the change takes effect. If the change leads to higher costs for Eurolight, the Other Party shall reimburse the costs.

## Miscellaneous

Art.25.25.1.Eurolight is entitled to call in third parties for performing the Agreement. 25.2.Third parties can not derive any rights from the Agreement. Notwithstanding the previous sentence, the limitations and exclusions included in these General Terms and Conditions and/or the Agreement apply as a third party beneficiary clause. Some third parties, like auxiliary personnel, have the express right to rely upon and directly enforce these provisions, on condition they have accepted the provisions. 25.3.The provisions in these General Terms and Conditions and the Agreement jointly determine the legal relationship between Parties and will precede prior made agreements or statements by Parties regarding the topics in the General Terms and Conditions and the Agreement and in that respect exclusively provide the evidence. 25.4.Subject to as far as such would be unacceptable according to standards of reasonability and fairness, the wording will initially determining for the interpretation of the General Terms and Conditions and the Agreement. If the wording, also considered in connection to one another, is not able to lead to reasonable interpretation in the given circumstances, the reasonable (commercial) intentions of Parties will count as a standard for the interpretation. Counter evidence against not prima facie uncertain wording, as well as evidence directed at other interpretation sources than the reasonable (commercial) intentions of Parties is not permitted. 25.5.Changes and additions made to these General Terms and Conditions and the Agreement shall be valid only if agreed in writing en can only be proved by an agreement in writing. 25.6.Should any, to the reasonable judgment of Eurolight, provision in these General Terms and Conditions and/or the Agreement be invalid or otherwise non-compelling, Eurolight has the right to terminate the further content of the Agreement, subject to as far as such would be acceptable in the given circumstances according to the standards of reasonability and fairness. 25.7.Notifications between Parties with respect to these General Terms and Conditions and/or the Agreement shall take place in writing. 25.8.The headings in these General Terms and Conditions and/or the Agreement have been included for easy reference only and have no independent meaning and do not affect the interpretation of the provisions. 25.9.Oral statements, promises and /or arrangements have no legal effect unless they are confirmed in writing. 25.10.Any failure or delay in exercising a right or remedy under these General Terms and Conditions and/or Agreement does not constitute a waiver of that right or remedy. 25.11.Provisions that are by their nature intended to continue after the termination of the Agreement shall continue to exist after the termination of the Agreement. Provisions concerning confidentiality, liability, guarantees, indemnifications for Intellectual Property rights and disputes and applicable law are among such provisions that survive. 25.12.The term 'in writing' in these General Terms and Conditions includes the use of e-mail. 25.13.Parties confirm that the provisions of these General Terms and Conditions and/or the Agreement, notably the provisions regarding liability, have been taken into account by setting the prices and payment conditions. 25.14.In the event of a conflict or discrepancy or inconsistencies between the Dutch text of these General Terms and Conditions and/or the Agreement and the English translation, the Dutch text shall always prevail.

## Dispute resolution and applicable law

Art.26.26.1.These General Terms and Conditions and/or the Agreement are subject to the laws of the Netherlands. 26.2.Any disputes will be submitted to the competent court in the place where Eurolight is established, although Eurolight always is entitled to submit a dispute to the competent court in the place of establishment of the Other Party. 26.3.A Consumer always is entitled to submit the dispute to the legally competent court, provided that he (the Consumer) duly notifies Eurolight of his choice in good time. In good time means here :within 1 (one) month after Eurolight has notified the Consumer in writing of its wish to submit the dispute to the court in its (Eurolight's) place of establishment. 26.4.If the Other Party is established outside the Netherlands, Eurolight is entitled to opt to submit the dispute to the competent court in the country or state in which the Other Party is established.

# HOW TO GET IN TOUCH WITH US

Masterlight  
Trade name of Eurolight BV

Industrieterrein 102-104  
5981 NC Panningen  
The Netherlands

C. of C. Venlo: 12044939  
VAT-no: NL8098.94.567B01

T. 0(031)77 3078684  
[info@masterlight.com](mailto:info@masterlight.com)  
[www.masterlight.com](http://www.masterlight.com)

**masterlight**

All rights reserved.  
Masterlight cannot be held responsible for  
typing or printing errors.

© Copyright by Eurolight BV.



Industrieterrein 102-104  
5981 NC Panningen  
The Netherlands

T. 0(031)77 3078684  
info@masterlight.com  
www.masterlight.com